

R&S® DSA DOCSIS® SIGNAL ANALYZER

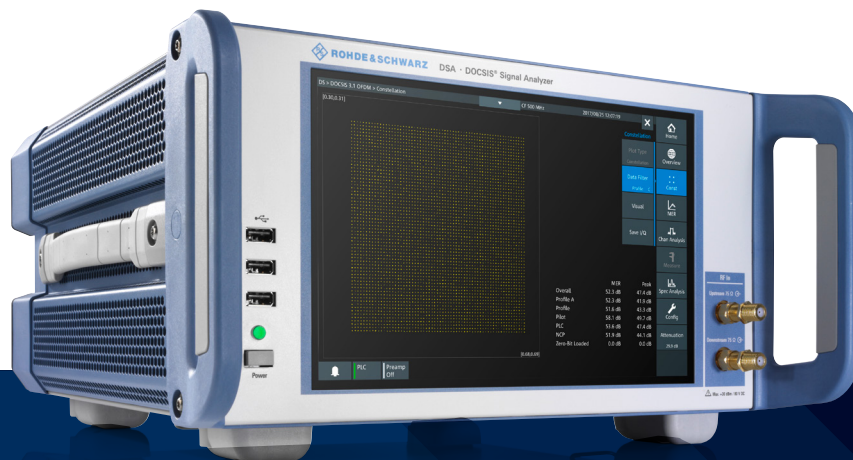

Best signal quality for
maximum data throughput



Product Brochure
Version 05.00

ROHDE & SCHWARZ

Make ideas real



AT A GLANCE

Only the highest signal quality ensures maximum throughput. The R&S® DSA DOCSIS® signal analyzer has been designed to support users by ensuring the highest signal quality. DOCSIS is the standard for transmitting IP data within hybrid fiber coaxial (HFC) cable TV networks. The new DOCSIS 3.1 standard supports unprecedented data rates, meeting the demand for increased data throughput.

The R&S® DSA allows precise, gapless signal analysis of DOCSIS 3.0, EuroDOCSIS 3.0 and DOCSIS 3.1 signals on the physical layer in real time. A user can detect effects that degrade signal quality, e.g. ingress, reflections and laser clipping. With its dual receivers, the R&S® DSA analyzes downstream and upstream signals. The frequency spectrum and key signal characteristics are displayed in compact overviews and diagrams, providing conclusive information about the signal quality.

In addition to DOCSIS signals, the R&S® DSA can analyze digital TV signals such as J.83/A/B/C and DVB-C. Although IP data transfer is consuming more and more transmission capacity, digital TV transmission continues to play an important role in cable TV networks. The R&S® DSA can analyze digital TV, helping users ensure interference-free coexistence of DOCSIS and digital TV channels.

Convenient operation via the 10.1" touchscreen, intuitive pictograms and logically structured menus allow even less experienced users to operate the instrument after a quick introduction.

Key facts

- ▶ Demodulation and analysis of DOCSIS 3.0/3.1 and EuroDOCSIS 3.0 downstream and upstream signals in real time
- ▶ Demodulation and analysis of digital TV signals (J.83/A/B/C, DVB-C) in real time
- ▶ Residual modulation error ratio (MER) ≥ 50 dB with DOCSIS 3.1
- ▶ Residual MER ≥ 56 dB with SC-QAM
- ▶ Dual receivers for
 - Downstream (47 MHz to 1794 MHz)
 - Upstream (5 MHz to 204 MHz)
- ▶ Integrated spectrum analyzer
- ▶ 10.1" (25.6 cm) touchscreen
- ▶ Remote desktop function
- ▶ SCPI/SNMP remote control

Front view



BENEFITS AND KEY FEATURES

Powerful, gapless DOCSIS downstream signal analysis

- ▶ FPGA based demodulation
- ▶ Real-time signal analysis
- ▶ Maximum performance
- ▶ Integrated spectrum analysis
- ▶ [page 4](#)

Detailed analysis of upstream signals

- ▶ Additional RF receiver for upstream signals (model .03)
- ▶ FPGA based real-time demodulation
- ▶ Detailed upstream analysis (R&S® DSA-K1500)
- ▶ DOCSIS timing analysis (R&S® DSA-K1505)
- ▶ Dynamic upstream signal analysis during live operation
- ▶ Upstream signal analysis with R&S® SFD
- ▶ Cable modem ranging test
- ▶ [page 6](#)

Digital TV signal analysis for interference-free parallel operation with DOCSIS

- ▶ FPGA based demodulation
- ▶ Real-time signal analysis
- ▶ [page 11](#)

Automatic channel measurements with R&S® TVSCAN 2.0

- ▶ Individual channel tables
- ▶ Verification in line with user-specific limits
- ▶ 2D and 3D visualization of measurement results
- ▶ [page 12](#)

Rear view



POWERFUL, GAPLESS DOCSIS DOWNSTREAM SIGNAL ANALYSIS

DOCSIS 3.1 signals can be up to 192 MHz wide and consist of several thousand modulated single carriers. In extreme cases, the single carriers can be modulated with 4096QAM and higher. To take full advantage of DOCSIS 3.1, it is essential to know the quality of an HFC cable network, the components and the signals being transmitted, both at the cable headend and in the field.

This is also true when developing and producing network components such as cable modem termination systems (CMTS), line amplifiers, cable modems, electro-optical converters and modules for remote PHY.

Overview of R&S® DSA interfaces and function blocks

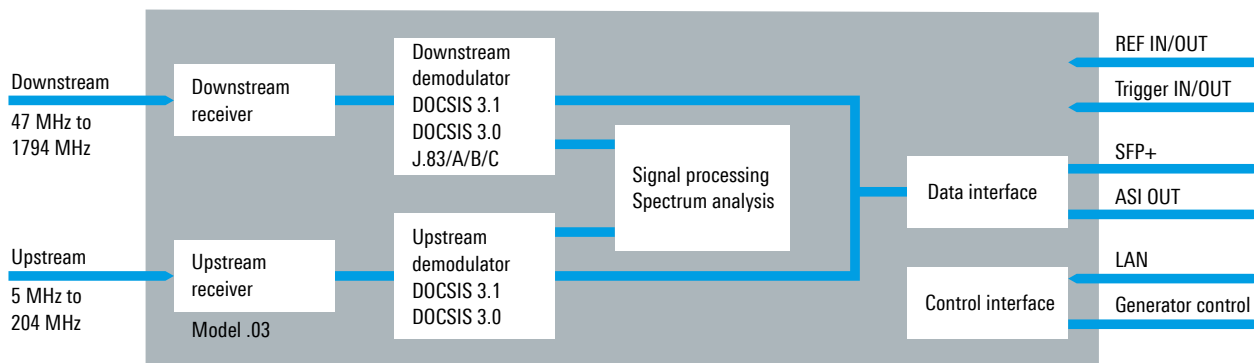

Assessing the quality of an HFC network with the R&S® DSA and a field strength meter

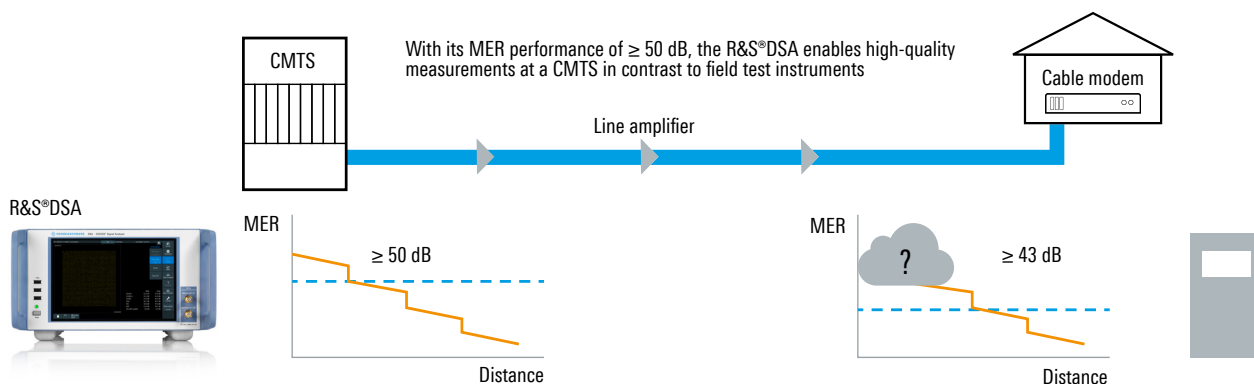

FPGA based demodulation

Demodulation of downstream signals in line with DOCSIS 3.0 (J.83/A/B/C), EuroDOCSIS 3.0 and DOCSIS 3.1 is handled by a powerful field programmable gate array (FPGA). Changes to standards are incorporated by simply upgrading the firmware, making the R&S®DSA a secure investment for the future.

An FPGA based demodulator also eliminates the limitations of measurement performance and precision typically encountered in a modem chipset based field test instrument.

The R&S®DSA meets the claim to be the reference for measurements on the physical DOCSIS layer.

Real-time signal analysis

Real time stands for fast and gapless signal processing with short refresh cycles when measuring signal characteristics and displaying traces, which significantly simplifies making adjustments and finding sporadic errors.

Maximum performance

To provide the highest possible data rates in the downstream, the DOCSIS 3.1 standard defines a MER value of ≥ 50 dB at the signal output of a CMTS. With its extremely high-quality RF receiver, the R&S®DSA can precisely measure signals at this level of quality, allowing users to assess the limits and margins at every point in the cable TV network.

Integrated spectrum analysis

An integrated spectrum analyzer supplements the versatile signal analysis functionality. Five markers, five traces and five user-defined masks are provided for detailed spectrum analysis. Other features include measurement of the phase noise and ACP, alternatively in the 6 MHz, 7 MHz or 8 MHz grid. The convenient zoom function on the touchscreen makes it easy to navigate within the spectrum.

Downstream DOCSIS 3.1 overview

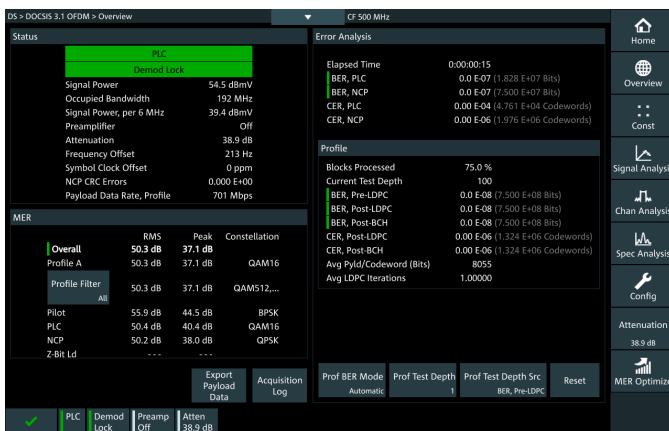

Downstream DOCSIS 3.1 spectrum analysis

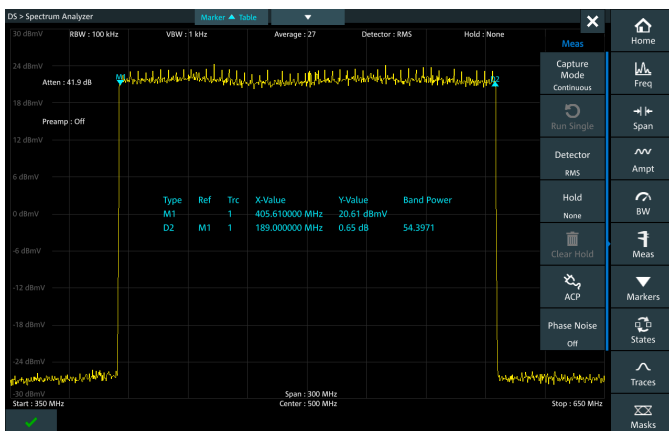

Downstream DOCSIS 3.1 constellation diagram with 4096QAM

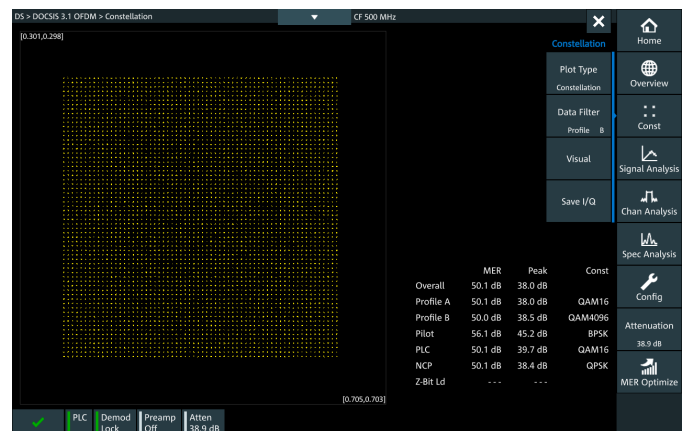

DETAILED ANALYSIS OF UPSTREAM SIGNALS

Up to now, the quality of internet connections has primarily been judged by the maximum download speed, but the upload speed is receiving more and more attention as an additional criterion, driven by cloud services and video uploading to social media platforms.

For higher data throughput in the upstream channel, the DOCSIS 3.1 standard offers an extended frequency range, greater channel bandwidths and modulation formats up to 4096QAM. However, performance may be impaired by cumulative interference originating from the connected cable modems and associated cabling.

Detailed knowledge of the physical conditions on the upstream channel is required in order to optimize data throughput and minimize interference during operation.

Additional RF receiver for upstream signals (model .03)

For analysis of upstream signals, the R&S®DSA model .03 has an additional RF receiver covering the frequency range from 5 MHz to 204 MHz. This receiver enables measurements in cable networks, during production or in the lab, where e.g. simultaneous analysis and monitoring of upstream and downstream signals is required.

FPGA based real-time demodulation

Just as for downstream signals, an FPGA in the R&S®DSA handles demodulation and analysis of upstream signals. Particularly for reliable acquisition and precise analysis of upstream burst signals and the interference that affects them in the upstream channel, high-performance signal processing is essential.



Upstream DOCSIS 3.1 overview

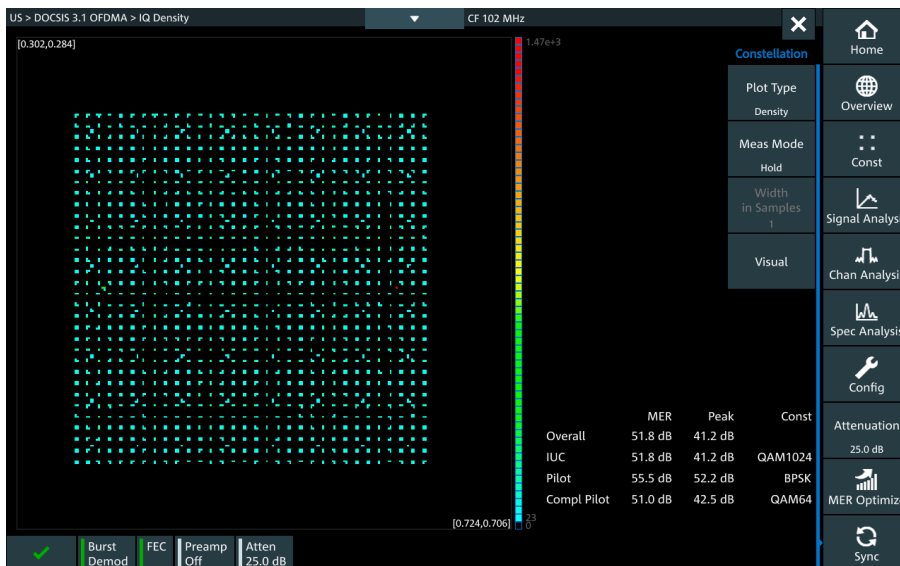

Upstream DOCSIS 3.1 I/Q density with 1024QAM

Detailed upstream analysis (R&S®DSA-K1500)

The R&S®DSA-K1500 upstream analysis option enables detailed analysis of A-TDMA (DOCSIS 3.0/EuroDOCSIS) and OFDMA (DOCSIS 3.1) signals. The overview screen, which displays the key signal states and measured values for the specific standard, is the core element of signal analysis. Additional views, including constellation, amplitude, group delay and phase, are available for further analysis of the transmission channel. Especially for long-term measurements, the MER, bit error ratio (BER) and signal power versus time measurements will be of interest for clearly detecting sporadic events or changes by trend. This enables users to precisely characterize the physical quality of an upstream channel and its components.

For defined transmission of upstream signals, a CMTS communicates the necessary signal parameters in an upstream channel descriptor (UCD). If a CMTS with this

information is not available, the signal parameters for analysis of an upstream signal can be manually entered in the R&S®DSA. Particularly in combination with the R&S®SFD DOCSIS® signal generator and R&S®CLGD DOCSIS® cable load generator, this enables users to perform upstream channel analyses even if they do not have a CMTS or a cable modem.

DOCSIS timing analysis (R&S®DSA-K1505)

Another factor crucial to the reliable operation of a DOCSIS network is its overall timing. The R&S®DSA-K1505 option extends the comprehensive set of measurements by:

- ▶ Upstream burst offset jitter measurement
- ▶ Upstream I/Q data synchronous streaming
- ▶ Downstream DOCSIS timestamp jitter measurement
- ▶ Downstream timestamp measurement with respect to 1 pulse per second (1PPS) input

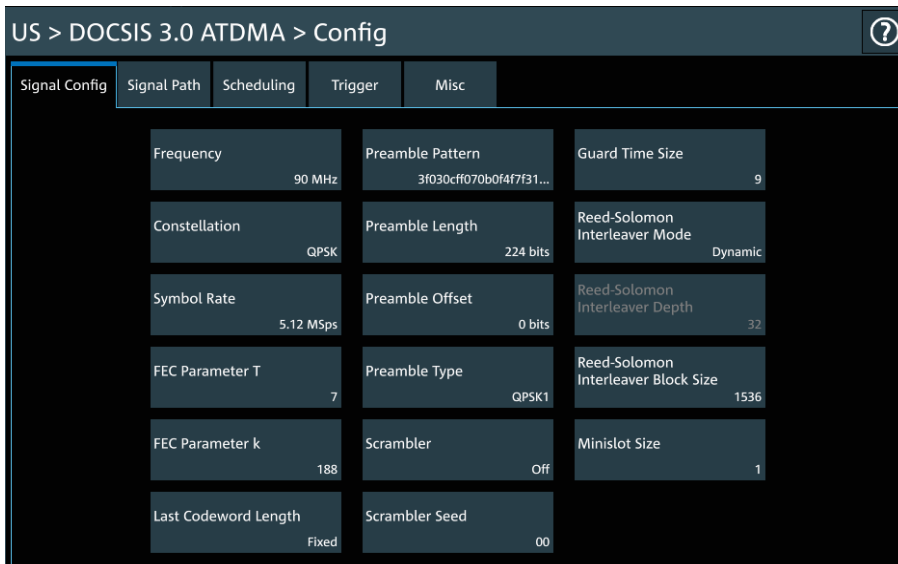

Upstream DOCSIS 3.0 signal configuration.

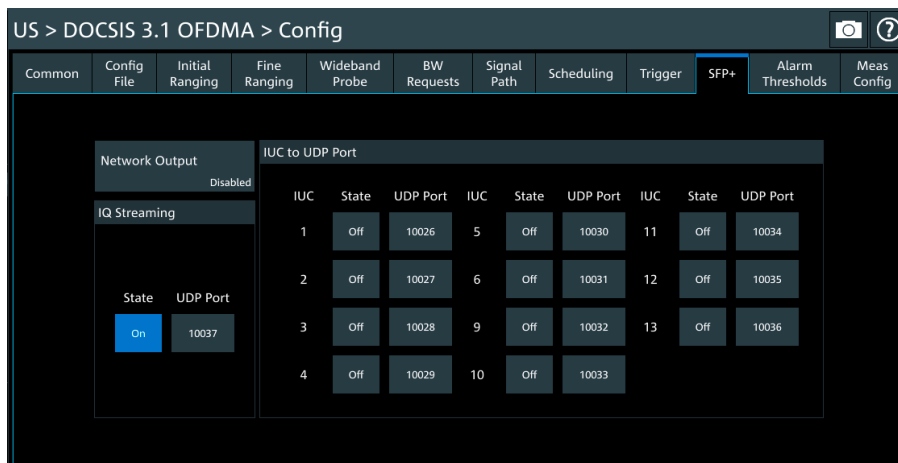

Configuration of upstream I/Q data synchronous streaming.

Dynamic upstream signal analysis during live operation

The unique dynamic upstream analysis function requires R&S®DSA model .03 with its two separate RF receivers for the upstream and downstream.

Measurements in the lab or in the field can be performed anywhere on the path between the cable modems and a CMTS or a remote PHY component. All that is needed are suitable test outputs to allow simultaneous access to the upstream and downstream signals.

Synchronizing to pulsed upstream signals is a technical challenge for a conventional signal analyzer, especially when there are a large number of signals in the upstream channel. This is no problem for the R&S®DSA.

Using its powerful signal processing and a complex algorithm, the R&S®DSA optimizes its internal timing based on the distances to the CMTS and the cable modems. Next, the upstream receiver performs a self-configuration based on the upstream channel descriptors (UCD) received via the downstream.

Afterwards, the R&S®DSA starts continuously scanning the selected downstream channel for relevant upstream bandwidth allocation map (MAP) messages for the designated upstream channel in order to detect the appropriate pulsed upstream signals and creates a list of associated service identifiers (SID). To perform measurements on a specific cable modem, this list can be filtered by media access control address (MAC) or SID.

Dynamic upstream analysis with list of MAC addresses

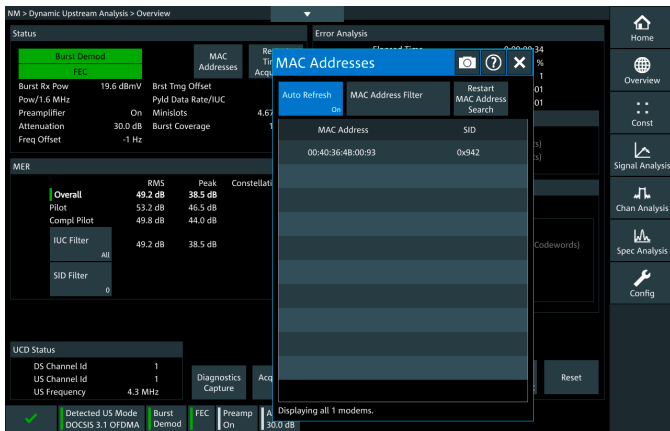

OFDMA upstream signal with traffic detect threshold set



Upstream signal analysis in HFC CATV networks

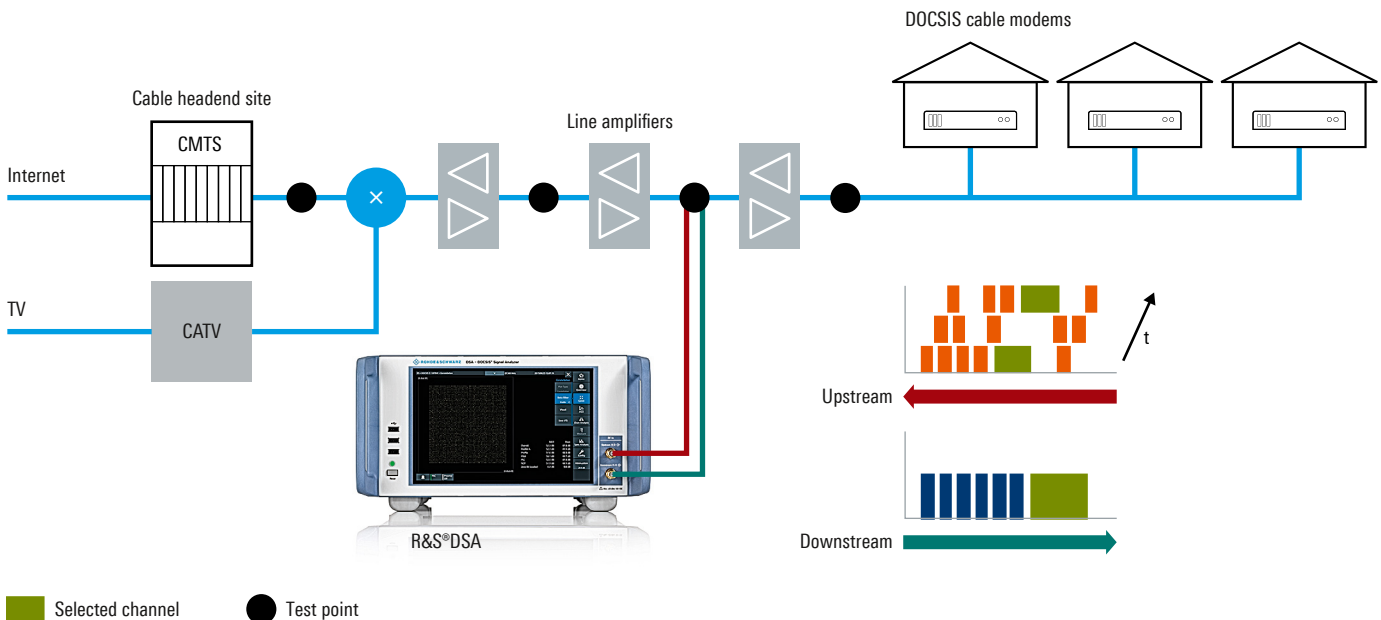

Upstream signal analysis with the R&S®SFD

The R&S®DSA DOCSIS® signal analyzer's SFD upstream analysis function – with signals delivered by the R&S®SFD DOCSIS® signal generator – offers a convenient way to test and measure network components and network segments using upstream signals.

The R&S®SFD serves as a signal source for standard-compliant upstream signals in line with DOCSIS 3.0 and DOCSIS 3.1.

Using a modulated auxiliary carrier, the signal parameters set on the R&S®SFD are transferred to the R&S®DSA and automatically set. This eliminates the time-consuming and error-prone process of matching the instrument settings to each other.

OFDMA upstream signal with auxiliary carrier at 150 MHz

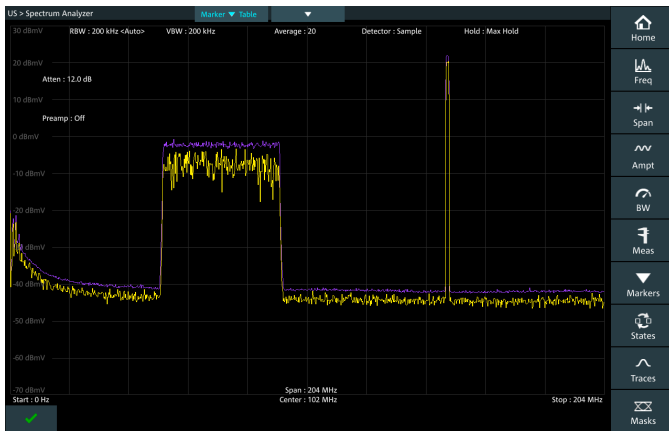

SFD upstream analysis function (with signals from the R&S®SFD) with status display for auxiliary carrier

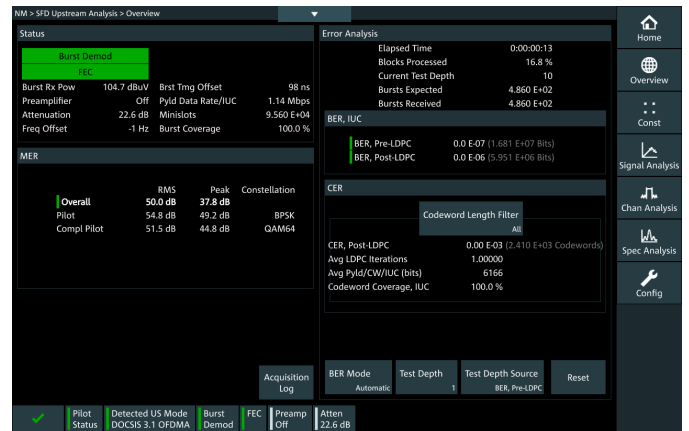

Testing of network components and network segments in the upstream with the R&S®DSA and R&S®SFD

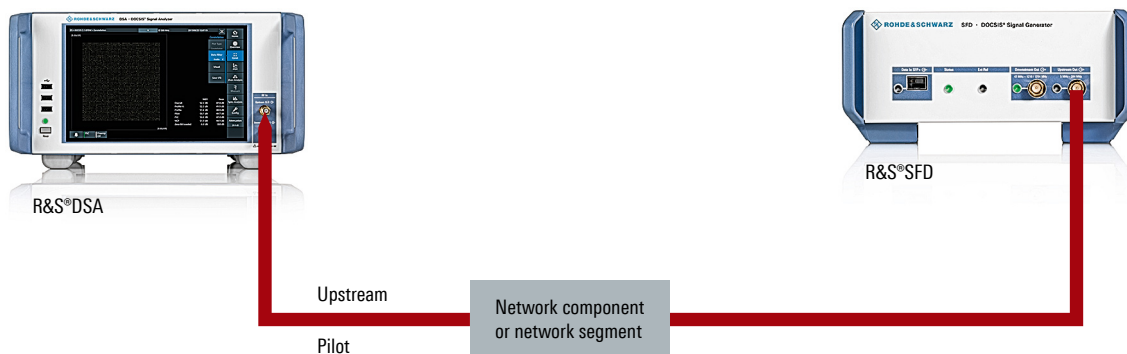

Cable modem ranging test

High-performance operation depends not only on the quality of the network components in the upstream channel, but also on the quality of the upstream signal transmitted by the cable modem. To measure upstream signals transmitted by a cable modem, the R&S®DSA DOCSIS® signal analyzer can be combined with the R&S®SFD DOCSIS® signal generator to form a compact test system.

Here the R&S®SFD takes over some of the tasks of a CMTS in order to trigger ranging by the modem. The R&S®DSA analyzes and displays the quality of the upstream signals transmitted by the modem. This allows fast and easy testing and comparison of cable modems from different manufacturers or production batches.

Cable modem ranging analysis



Cable modem ranging with the R&S®DSA and R&S®SFD

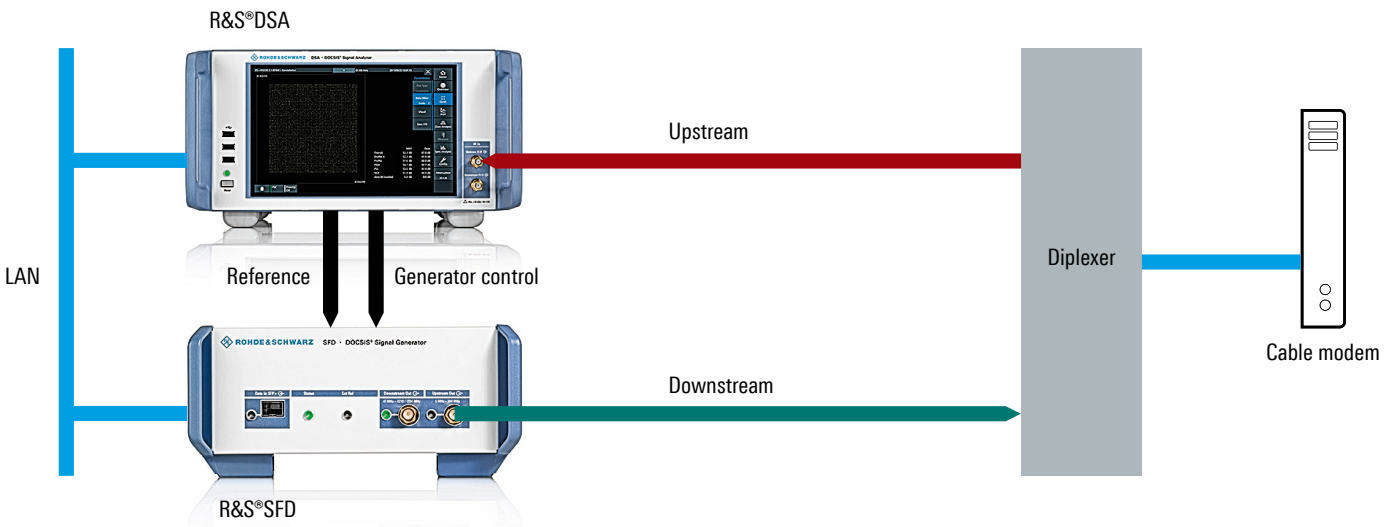

DIGITAL TV SIGNAL ANALYSIS FOR INTERFERENCE-FREE PARALLEL OPERATION WITH DOCSIS

Digital TV will be transmitted over TV cable networks for many years before it is completely replaced by IP TV over DOCSIS. Until then, HFC cable network operators must ensure that DOCSIS and TV channels operate in parallel without negatively affecting one another. Equipped with the R&S®DSA-K1501 option, the R&S®DSA is able to analyze both digital TV and DOCSIS signals.

FPGA based demodulation

The R&S®DSA uses FPGAs to demodulate digital TV signals in line with the J.83/A/B/C and DVB-C standards. For further processing, the demodulated MPEG-2 transport streams are available at the ASI output located on the rear of the R&S®DSA.

Real-time signal analysis

Real-time signal analysis not only offers a speed advantage, it also facilitates measurements such as BER, MER and signal power versus time, as well as constellation measurements for displaying sporadic errors.

The R&S®DSA can analyze digital TV signals in the frequency range from 47 MHz to 1794 MHz. The R&S®DSA-K1502 option enables the analysis of these digital TV signals via the upstream RF input of the R&S®DSA (model .03) to perform amplifiers measurements in line with the IEC 60728-3 standard.

J.83 overview

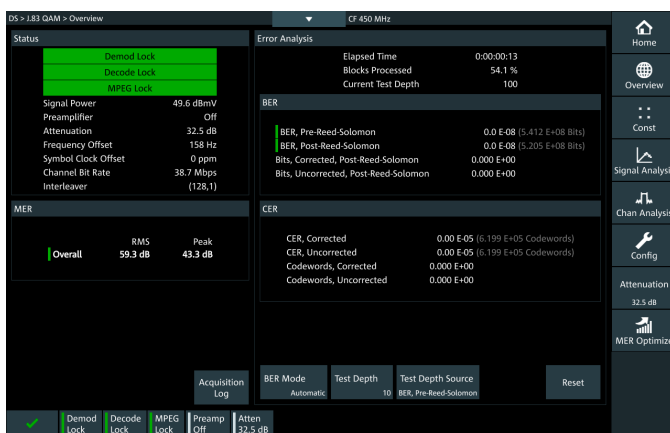

J.83 constellation diagram with 256QAM



J.83 BER versus time with sporadic errors

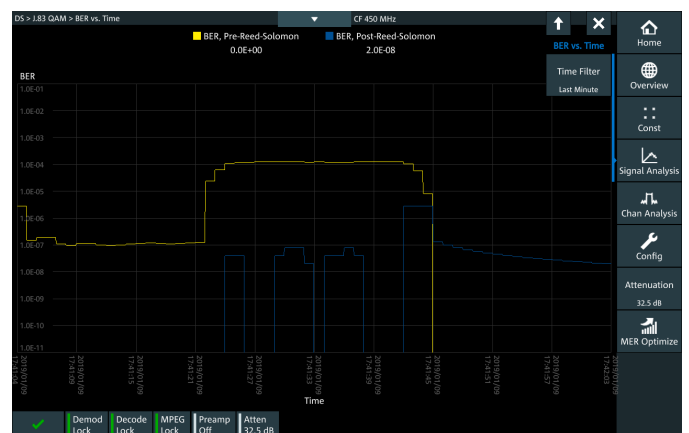

AUTOMATIC CHANNEL MEASUREMENTS WITH R&S®TVSCAN 2.0

Today's cable TV systems normally have over one hundred occupied channels. To manually measure these channels separately and record the results would be very time-consuming and expensive. These tasks can be accomplished automatically, effectively, quickly and easily with the R&S®TVSCAN 2.0 software (R&S®DSA-K950 option).

Individual channel tables

Automatic measurements are based on the user-defined channel tables, measurements and related limits. All parameters in the channel tables can be predefined so that the R&S®DSA is correctly set for each channel.

Verification in line with user-specific limits

Measurements are made in line with a selected, user-specific limit table that defines the parameters to be measured and their tolerance limits. Measurement results are stored in an SQLite database on the R&S®DSA, a PC or a network drive. Limit violations are indicated graphically.

2D and 3D visualization of measurement results

Analysis of measurement results is supported by 2D and 3D graphs of the data. This allows quick analysis of even big data collections so that trends in signal degradation or short-term degradations can be easily identified.

Channel table with individual settings per channel

Device Settings (read only)	Limit Values (read only)										Channel Settings (read only)										
	1	2	3	4	5	6	7	8	9		1	2	3	4	5	6	7	8	9		
Channel Name	D1	D2	D3	D4	D5	D6	D7	D8	D9		D1	D2	D3	D4	D5	D6	D7	D8	D9		
Description																					
TV Standard	DVB-C / 383...	DVB-C / 383...	DVB-C / 383...	DVB-C / 383...	DVB-C / 383...	DVB-C / 383...	DVB-C / 383...	DVB-C / 383...	DVB-C / 383...		DVB-C / 383...	DVB-C / 383...	DVB-C / 383...	DVB-C / 383...	DVB-C / 383...	DVB-C / 383...	DVB-C / 383...	DVB-C / 383...	DVB-C / 383...		
Center / Vision Carrier Frequency	588.00 MHz	594.00 MHz	602.00 MHz	610.00 MHz	618.00 MHz	626.00 MHz	632.00 MHz	642.00 MHz	650.00 MHz		658.00 MHz	668.00 MHz	678.00 MHz	688.00 MHz	698.00 MHz	708.00 MHz	718.00 MHz	728.00 MHz	738.00 MHz		
Frequency Offset	0.00 Hz	0.00 Hz	0.00 Hz	0.00 Hz	0.00 Hz	0.00 Hz	0.00 Hz	0.00 Hz	0.00 Hz		0.00 Hz	0.00 Hz	0.00 Hz	0.00 Hz	0.00 Hz	0.00 Hz	0.00 Hz	0.00 Hz	0.00 Hz		
Power Limit Offset	0.00 dB	0.00 dB	0.00 dB	0.00 dB	0.00 dB	0.00 dB	0.00 dB	0.00 dB	0.00 dB		0.00 dB	0.00 dB	0.00 dB	0.00 dB	0.00 dB	0.00 dB	0.00 dB	0.00 dB	0.00 dB		
Reference Level Mode	Automatic	Automatic	Automatic	Automatic	Automatic	Automatic	Automatic	Automatic	Automatic		Automatic	Automatic	Automatic	Automatic	Automatic	Automatic	Automatic	Automatic	Automatic		
Reference Level	0 dBmV	0 dBmV	0 dBmV	0 dBmV	0 dBmV	0 dBmV	0 dBmV	0 dBmV	0 dBmV		0 dBmV	0 dBmV	0 dBmV	0 dBmV	0 dBmV	0 dBmV	0 dBmV	0 dBmV	0 dBmV		
Pre Selector	On	On	On	On	On	On	On	On	On		On	On	On	On	On	On	On	On	On		
Pre Amplifier	On	On	On	On	On	On	On	On	On		On	On	On	On	On	On	On	On	On		
Attenuation	0 dB	0 dB	0 dB	0 dB	0 dB	0 dB	0 dB	0 dB	0 dB		0 dB	0 dB	0 dB	0 dB	0 dB	0 dB	0 dB	0 dB	0 dB		
Sideband Position (Spectral Inversion)	Automatic	Automatic	Automatic	Automatic	Automatic	Automatic	Automatic	Automatic	Automatic		Automatic	Automatic	Automatic	Automatic	Automatic	Automatic	Automatic	Automatic	Automatic		
Group Delay																					

3D display of the MER value versus channels and time

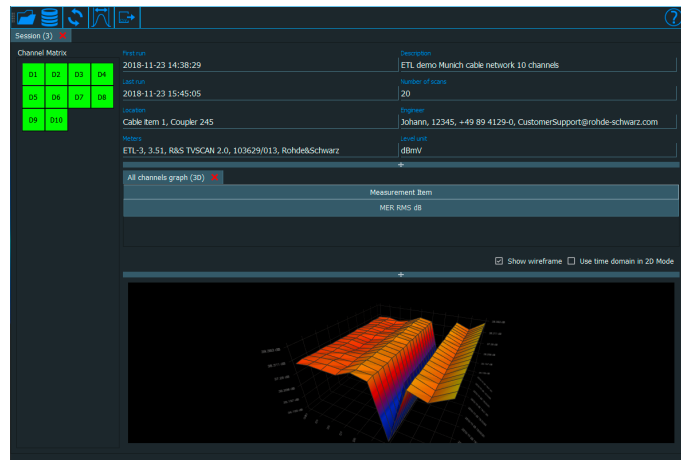

SPECIFICATIONS IN BRIEF

Specifications in brief		
RF parameters		
Frequency range	downstream with J.83 QAM	47 MHz to 1794 MHz
	upstream (model .03 only)	5 MHz to 204 MHz
Level	downstream per 24 MHz	up to 67 dBmV (+18 dBm)
	upstream (model .03 only)	up to 67 dBmV (+18 dBm)
MER (downstream)	47 MHz to 600 MHz	≥ 50 dB
	600 MHz to 1000 MHz	≥ 48 dB
	1000 MHz to 1794 MHz	≥ 47 dB
	with SC-QAM, 100 MHz to 1200 MHz	≥ 56 dB
Spectrum analyzer		
Level accuracy		±0.5 dB at +25°C
Resolution bandwidth		10 Hz to 3 MHz, zero span
Downstream demodulation		
DOCSIS 3.0 (SC-QAM), J.83/A/B/C	in line with CM-SP-PHYv3.0, CM-SP-DRFI and ITU-T J.83	
Symbol rate		0.4 Msymbol/s to 7.2 Msymbol/s
Constellation		4QAM to 256QAM (J.83A/C up to 1024QAM)
DOCSIS 3.1 (OFDM)	in line with CM-SP-PHYv3.1	
Bandwidth		up to 192 MHz
FFT modes		4k, 8k
Constellation		16QAM to 16384QAM
Upstream demodulation		
DOCSIS 3.0 (A-TDMA)	in line with CM-SP-PHYv3.0	
Symbol rate		1.28 Msymbol/s to 5.12 Msymbol/s
Constellation		QPSK to 256QAM, DQPSK, DQAM16
DOCSIS 3.1 (OFDMA)	in line with CM-SP-PHYv3.1	
Bandwidth		up to 96 MHz
FFT modes		2k, 4k
Constellation		QPSK to 2048QAM
General data		
Screen		10.1" touchscreen
Resolution		1280 × 800 pixel
Dimensions	W × H × D	358 mm × 196 mm × 411 mm (14.1 in × 7.7 in × 16.2 in)
Weight		≤ 7.5 kg (16.5 lb)

ORDERING INFORMATION

Designation	Type	Order No.
Base units		
DOCSIS® signal analyzer, for DOCSIS and digital cable TV, DOCSIS 3.1 downstream demodulator included	R&S®DSA	2118.7800.02
DOCSIS® signal analyzer, for DOCSIS and digital cable TV, DOCSIS 3.1 downstream demodulator included, with upstream receiver	R&S®DSA	2118.7800.03
Accessories supplied		
Power cable, quick start guide		
Software options (firmware)		
Upstream demodulation/analysis	R&S®DSA-K1500	2118.7723.02
Upstream RF IN, for J.83	R&S®DSA-K1502	2118.7923.02
J.83, D3.0 DS demodulation/analysis	R&S®DSA-K1501	2118.7730.02
DOCSIS timing analysis	R&S®DSA-K1505	1345.2130.02
R&S®TVSCAN 2.0, automated measurement of multiple TV and DOCSIS channels	R&S®DSA-K950	2118.8236.02
Extra		
19" adapter 4E 3/4 T350	R&S®ZZA-KN11	1175.3104.00

Warranty		
Base unit		3 years
All other items ¹⁾		1 year
Service options		
Extended warranty, one year	R&S®WE1	Please contact your local Rohde & Schwarz sales office.
Extended warranty, two years	R&S®WE2	
Extended warranty with calibration coverage, one year	R&S®CW1	
Extended warranty with calibration coverage, two years	R&S®CW2	
Extended warranty with accredited calibration coverage, one year	R&S®AW1	
Extended warranty with accredited calibration coverage, two years	R&S®AW2	
Extended calibration coverage, two years	R&S®CC2	
Extended calibration coverage, three years	R&S®CC3	
Extended calibration coverage, four years	R&S®CC4	
Extended calibration coverage, five years	R&S®CC5	

¹⁾ For options installed, the remaining base unit warranty applies if longer than 1 year. Exception: all batteries have a 1 year warranty.

FROM PRESALES TO SERVICE. AT YOUR DOORSTEP.

The Rohde & Schwarz network in over 70 countries ensures optimum on-site support by highly qualified experts.

User risks are reduced to a minimum at all project stages:

- ▶ Solution finding/purchase
- ▶ Technical startup/application development/integration
- ▶ Training
- ▶ Operation/calibration/repair



Service at Rohde & Schwarz You're in great hands

- ▶ Worldwide
- ▶ Local and personalized
- ▶ Customized and flexible
- ▶ Uncompromising quality
- ▶ Long-term dependability

Rohde & Schwarz

The Rohde&Schwarz technology group is among the trail-blazers when it comes to paving the way for a safer and connected world with its leading solutions in test & measurement, technology systems and networks&cybersecurity. Founded more than 85 years ago, the group is a reliable partner for industry and government customers around the globe. The independent company is headquartered in Munich, Germany and has an extensive sales and service network with locations in more than 70 countries.

www.rohde-schwarz.com

Sustainable product design

- ▶ Environmental compatibility and eco-footprint
- ▶ Energy efficiency and low emissions
- ▶ Longevity and optimized total cost of ownership

Certified Quality Management

ISO 9001

Certified Environmental Management

ISO 14001

Rohde & Schwarz training

www.training.rohde-schwarz.com

Rohde & Schwarz customer support

www.rohde-schwarz.com/support

