

ROHDE & SCHWARZ

Make ideas real



R&S®ATS800 CATR SETUP FOR 5G NR MILLIMETERWAVE SIGNALS

Product Brochure | Version 02.00

Millimeterwave and 5G NR
antenna characterization and
device testing on a small footprint

R&S®ATS800R rackmountable model

R&S®ATS800B benchtop model

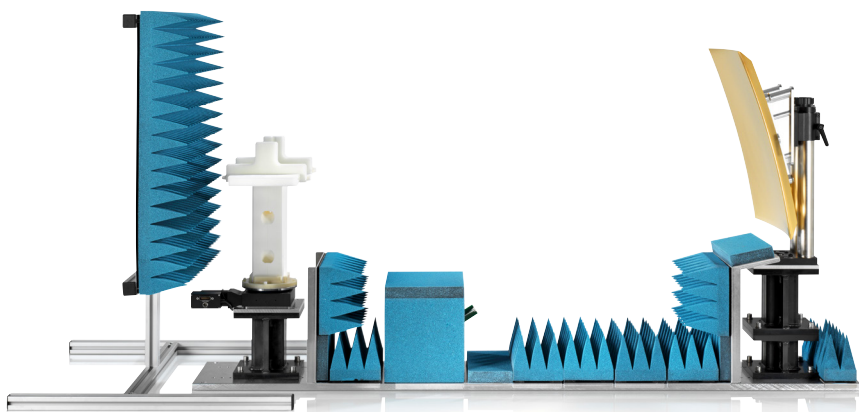

R&S®ATS800 FAMILY

The R&S®ATS800 CATR setup family offers a very compact environment for 5G antenna, module and device characterization in the 20 GHz to 50 GHz range. It is an essential tool for R&D as well as design verification for both active and passive devices. The R&S®ATS800 comes as an accessible horizontal benchtop setup (R&S®ATS800B) or as a fully anechoic and shielded vertical setup (R&S®ATS800R) which can also be mounted on top of a rack.

Key facts

- ▶ Very compact far field over-the-air (OTA) setup based on compact antenna test range (CATR) technology
- ▶ Unrivaled quiet zone size and accuracy with just 0.75 m² footprint
- ▶ State-of-the-art reflector surface precision for high frequency support
- ▶ Unique benchtop or rackmountable CATR setup
- ▶ Automated high-precision positioner (optional)
- ▶ Indirect far field method – as recommended by 3GPP for 5G OTA testing

R&S®ATS800B

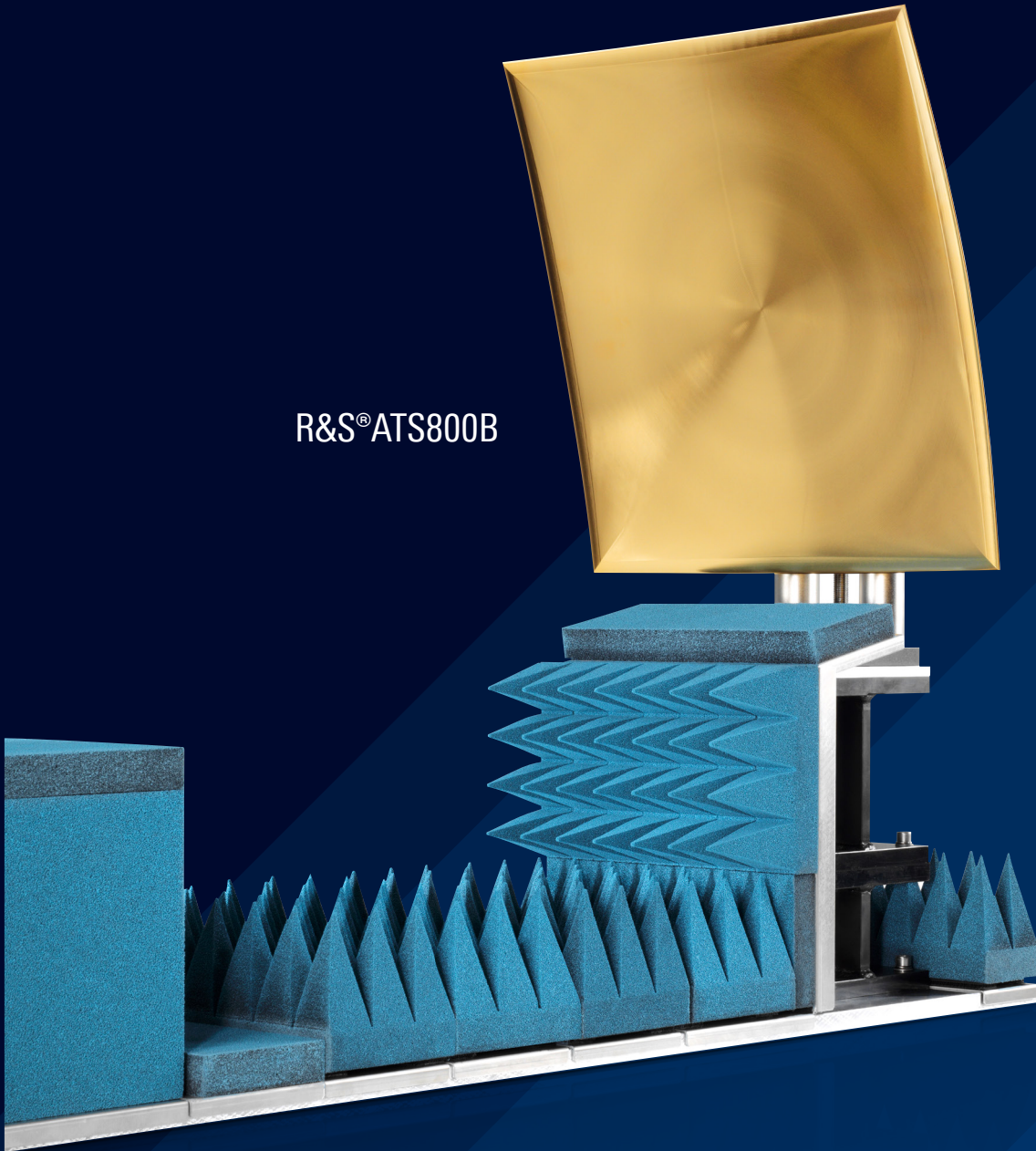

Based on the compact antenna test range (CATR) principle, the R&S®ATS800 allows over-the-air RF measurements under far field conditions in even the smallest lab spaces. It helps optimize the overall RF module performance in the early development phases, preventing costly and time-consuming modifications for a large number of prototypes at a later stage. OTA RF testing during development reduces costs and keeps the product launch on schedule with faster time to market.

In combination with its test equipment, Rohde & Schwarz offers a one-stop solution for lab based 5G device and antenna performance testing – ensuring fast and smooth characterization in the mmWave frequency range.

In summary, the R&S®ATS800 CATR setup is a compact, convenient and accurate solution for testing 5G modules and devices in the 5G mmWave frequency bands.

R&S®ATS800R



5G is all about data, speed and reliability in high frequency millimeterwave (mmWave) bands. The lack of conventional external RF connectors on mmWave devices makes 5G device characterization challenging. 5G antenna, chipset and UE manufacturers as well as mobile operators need a viable and easy to operate over-the-air (OTA) solution for research, diagnostics, debugging and type approval. Compact CATR setups are ideal for this.

R&S®ATS800B

BENCHTOP CATR SETUP

The R&S®ATS800B is a very compact and accessible benchtop CATR for enormous flexibility in creating various test setups that provide a highly accurate 20 cm quiet zone. The open design makes it easy to use with devices of different sizes and weights. Also, oddly shaped devices are not a problem when positioning and testing. The open architecture enables great flexibility and easy setup, making it ideal for education, universities and research labs as well as RF development labs.

The R&S®ATS800B feed antenna offers a wide frequency range and is easily connected to any type of test equipment such as network analyzers as well as signal generators, signal analyzers and radio communication testers via RF cables supporting up to 50 GHz.

The CATR reflector is a member of the Rohde&Schwarz reflector family. It features rolled edges to prevent scattering and reflections that could contaminate the high-quality quiet zone created by the parabolic shape. The low surface roughness ensures a very high upper frequency limit. The gold-plated finishing provides stable performance over time by preventing oxidation that would increase surface roughness.

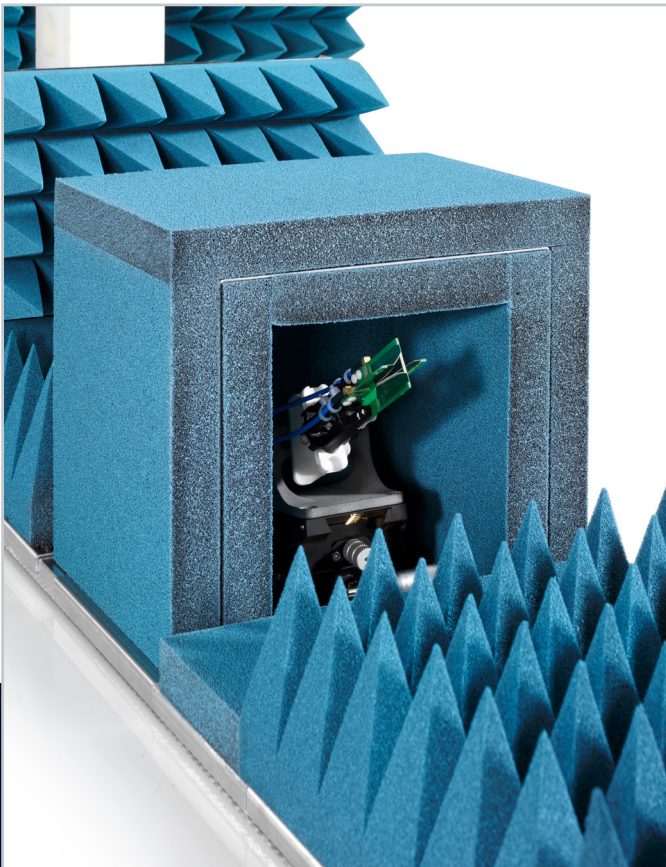

Feed antenna

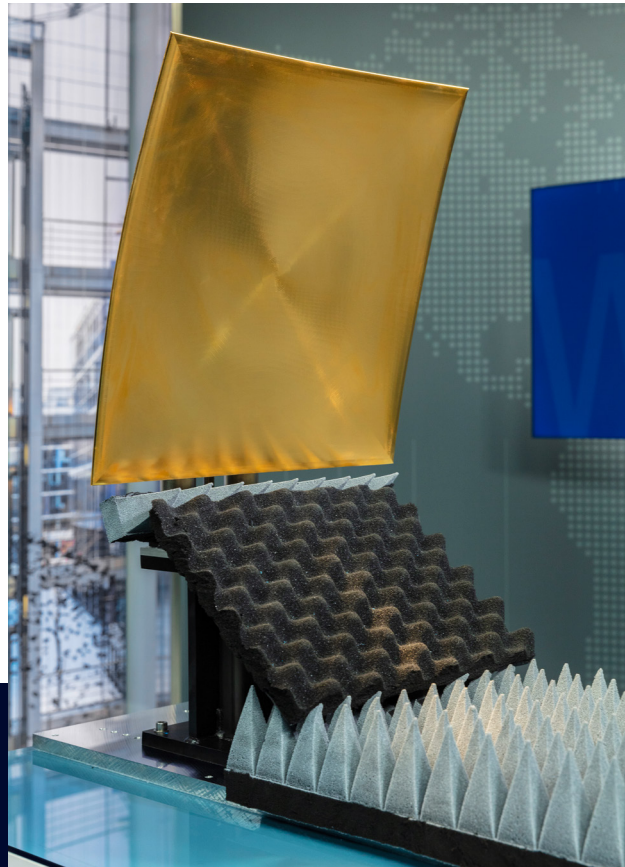

Reflector

The fixture provided with the R&S®ATS800B is made of RF transparent material to minimize the influence on measurements. The flexible clamping feature easily accommodates different device sizes and shapes.

The optional 2D azimuth rotation stage enhances the flexibility and usability of the R&S®ATS800B and allows measurement of 2D radiation patterns. A motor controller is provided for easy control via the USB or RS-232 interface with various supported application programming interfaces (API).



DUT fixture

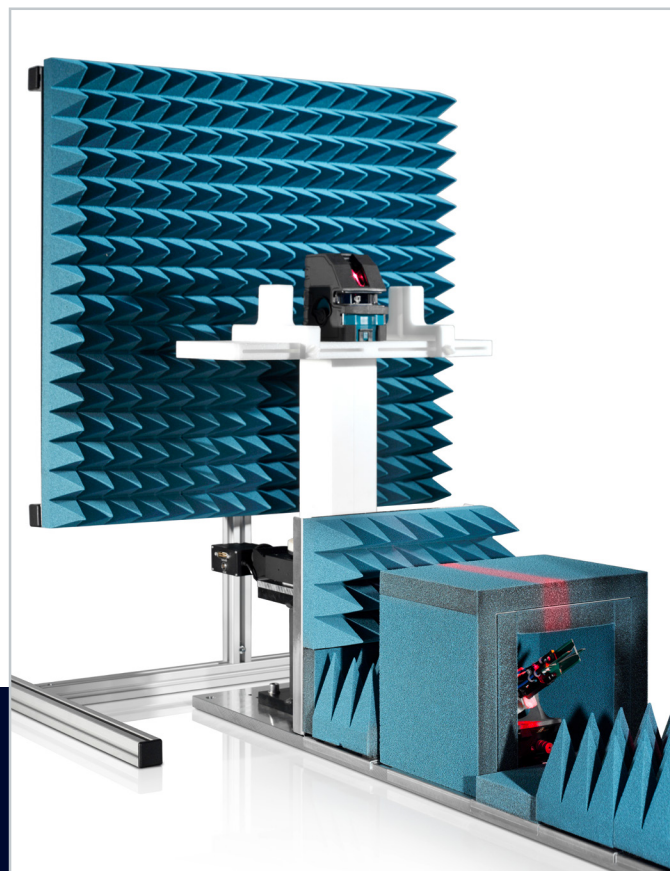

Positioner

R&S®ATS800R

RACKMOUNTABLE CATR SETUP

The R&S®ATS800R CATR setup uses many of the components from the R&S®ATS800B benchtop setup and arranges them for more industrial environments.

The same gold-plated parabolic CATR reflector with rolled edges is used, but installed under the ceiling of the compact anechoic chamber. This further decreases the footprint and prevents accidental contact with the reflector.

The feed antenna is also the same as in the benchtop setup and is moved to the backwall of the anechoic chamber for the same illumination of the reflector while keeping it less prone to contact and better protected.

The DUT is placed on the bottom of the anechoic chamber and can be tested with ease. The device fixture allows flexible DUT mounting inside the 20 cm high-quality quiet zone. This can be done with the pin holes or threaded holes that also match the mechanical interface for Rohde&Schwarz calibration antennas.

A shielded, manually lockable metal door with high-quality absorbers and RF gaskets completes the setup. The entire anechoic chamber is on casters for easy transportation

between labs. It can be placed next to a test bench or used as a tabletop chamber. Alternatively, it can also be mounted on top of a 12 HU rack for the convenient storage of both the CATR test environment and testing equipment for assessing the DUT. This further reduces the test setup footprint and enables far field OTA testing within limited lab space.

The optional remote radio head (RRH) holder on the back of the chamber reduces the necessary cable length and the critical cable loss at mmWave frequencies. This enables close integration with the R&S®CMP200 and R&S®CMX500 radio communication testers and their remote radio heads. The R&S®ATS800R is the ideal OTA environment for RF preformance testing, FR2 application testing and data performance testing in combination with the R&S®CMX500.

The R&S®AMS32-ATS calibration and OZ verification for CATR systems software tool in conjunction with a network analyzer (e.g. R&S®ZNA) enable convenient initial alignment of the reflector and can also perform RF path loss calibration for the R&S®ATS800R.



Complete setup

RRH holder

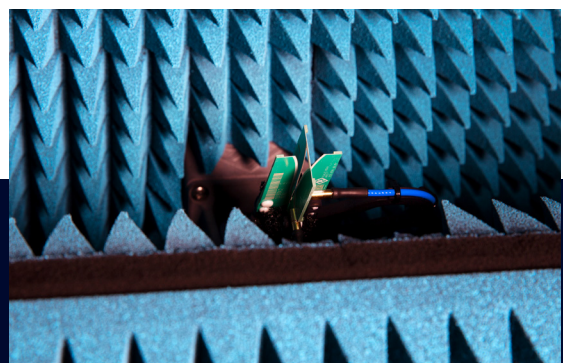

Feed antenna

3D POSITIONER AND EXTREME TEMPERATURE TEST SOLUTION

Optional 3D positioner

A 3D azimuth over elevation positioner is available as an optional extension to the R&S®ATS800R. It replaces the DUT fixture and enables a full 3D assessment of the DUT rather than only testing in a fixed stable position. The 3D positioner can independently rotate a smartphone or tablet device by 360° along both axes. While moving, the encoders provide an accurate position at the control interface of the positioner for trouble-free and accurate operation. To test passive antennas that need an RF connection, additional rotary joints and feed cables are also available for full spherical testing. The 3D positioner and optional rotary joints can be added to any installed R&S®ATS800R.

Climate option for tests under extreme temperature conditions

The extreme temperature test option comes with an isolated yet RF transparent enclosure for analyzing temperature effects on the DUT. The DUT is placed inside the enclosure which can be heated or cooled using hot or cold airstreams supplied by an external heat pump. Thickly insulated, temperature-resistant hoses enable testing in a wide temperature range. The dome shaped lid is made from RF transparent material that tightly encloses the DUT and has little to no influence on the RF radiation. The enclosure also accommodates bigger devices comfortably inside the extreme temperature test option. The temperature test enclosure can be added to any installed R&S®ATS800R but cannot be combined with the 3D positioner.

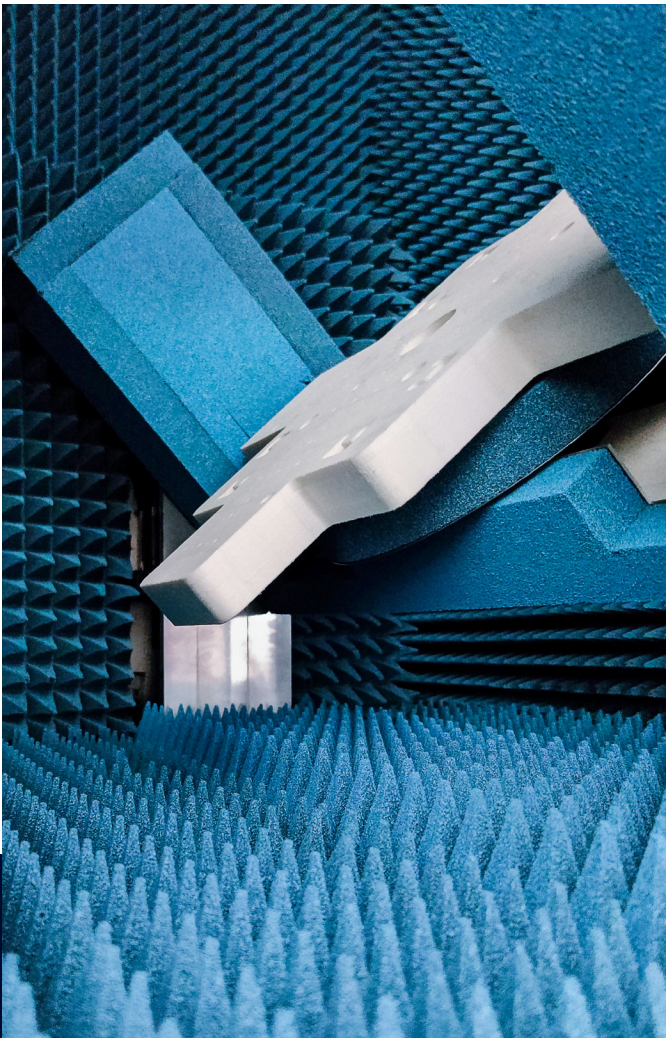

Optional 3D positioner

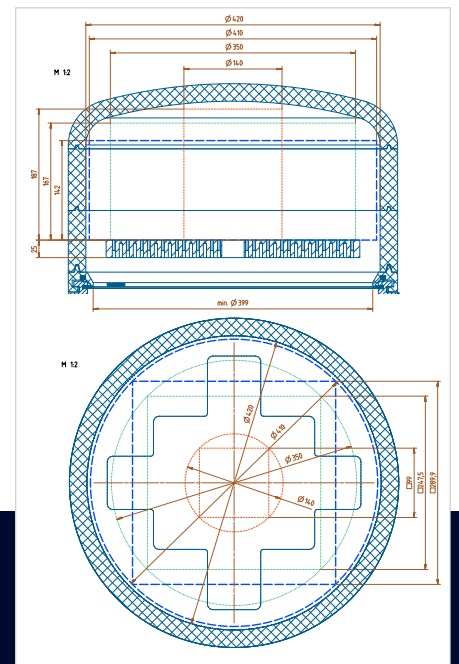

Climate option

ADDITIONAL OPTIONS

Link antenna for testing under signaling conditions

In 5G NSA (non-standalone) signaling setups, an anchor cell in a legacy technology (LTE) is provided for the DUT at the same time as the 5G FR2 signal. In the R&S®ATS800R, the FR2 signal is supplied from the feed antenna via the reflector to the DUT and at the same time an optional additional antenna can provide the anchor signal. There are various options for installing the link antennas with or without positioner. Up to 4x4 MIMO anchor signals, for example, are supported through optional link antennas on the side next to the DUT fixture or positioner.

Alternatively, an RF coupling plate can be added to provide a SISO anchor or to perform coupled tests of legacy technologies supported by the DUT.

Phantoms in the chamber

The R&S®ATS800R provides enough testing volume to accommodate a phantom head or phantom hands. Testing phone type devices with phantoms in place is a requirement in CTIA test plans and the optional phantom fixture in the R&S®ATS800R is perfect for mounting these phantoms in the chamber.

Due to the significant weight of phantoms, the fixture cannot be combined with the optional 3D positioner.



Side antennas



Phantom head

What is happening inside the chamber

Viewing the inside of an anechoic chamber during testing is difficult because testing must be performed with the door closed in order to provide proper shielding. The camera option allows close examination of the DUT while testing is in progress. This is also possible from a remote location since the camera uses an Ethernet connection and a dedicated IP address for login. And because heat dissipation of 5G terminals is a potential issue, the camera provides the added benefit of infrared vision including a heat map display of the device under test.

Further expandability

The R&S®ATS800R can be equipped with a dozen additional feedthroughs to run cables into the shielded chamber without compromising shielding effectiveness. Rohde&Schwarz offers an extensive list of feedthroughs including various RF types, USB, Ethernet and power feedthroughs. This helps tailor the R&S®ATS800R interfaces to match your individual needs when connecting the device under test.

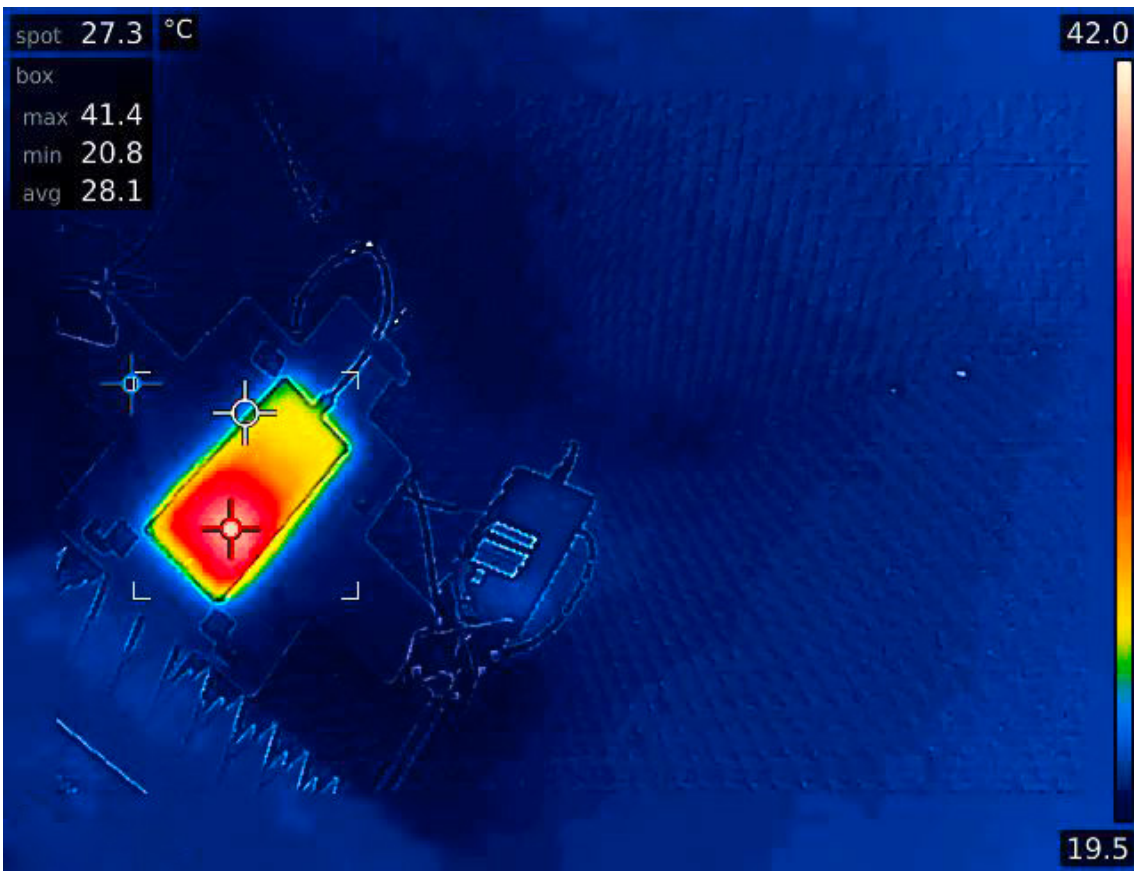

Heat map

Rohde & Schwarz

The Rohde & Schwarz technology group is among the trailblazers when it comes to paving the way for a safer and connected world with its leading solutions in test & measurement, technology systems and networks & cybersecurity. Founded more than 85 years ago, the group is a reliable partner for industry and government customers around the globe. The independent company is headquartered in Munich, Germany and has an extensive sales and service network with locations in more than 70 countries.

www.rohde-schwarz.com

Service that adds value

- ▶ Worldwide
- ▶ Local and personalized
- ▶ Customized and flexible
- ▶ Uncompromising quality
- ▶ Long-term dependability

Sustainable product design

- ▶ Environmental compatibility and eco-footprint
- ▶ Energy efficiency and low emissions
- ▶ Longevity and optimized total cost of ownership

Certified Quality Management

ISO 9001

Certified Environmental Management

ISO 14001

Rohde & Schwarz training

www.training.rohde-schwarz.com

Rohde & Schwarz customer support

www.rohde-schwarz.com/support

