



## Suga Test Instruments Weathering General Catalog



# WEATHERING

Please be sure to check safety and operating environment and to read the specification sheet, drawing, installation manual and installation check sheet before installing the test instruments. The test instruments shall be carried out daily cleaning, daily checking, regular maintenance and calibration. Please be sure to read the instruction manual and operate the test instruments properly.

# Achieving supremacy as the expert maker of weather meters.

Since selling first domestic carbon type weather meter in 1952, we have been supplying weather meters which are simulating natural deterioration to the world-wide market as expert manufacturer.

- Integrated production system from lamp to test unit.
- Participating international standard activity for weathering since 1958.
- Established SUGA Weathering Technology Foundation (SWTF) in 1981 to support and develop the weathering technology.

Keep supplying weathering meters possible only by Suga.



## CONTENTS

Weatherability .....	3-4
Light Source of Weathering Test .....	5-6
Only SUGA Technology .....	7-10
Super Xenon Weather Meters .....	11-12
Xenon Weather Meters .....	13-14
Metaling™ Weather Meters .....	15-16
Sunshine Weather Meters .....	17
UV Fluorescent Weather Meters .....	18
Ultra Violet Fade Meter .....	19
Xenon Weather Meters (Table Top Type) .....	20
Ultraviolet Fade Meters for Glass .....	21
Peripheral Equipments .....	22
Specification .....	23-26
Typical Standard and Applied Models .....	27-28
Calibration .....	29
Peripheral Equipments for Calibration .....	30
Corelation of Outdoor Exposure and Laboratory Exposure .....	31-32
Outdoor Exposure Apparatus .....	33
Go Through with Advanced Weathering .....	34
- Spectral Radiation Tester .....	35
- Super Xenon Weather Meter (H <sub>2</sub> O <sub>2</sub> ) .....	36
- Custom Made Instruments .....	37-38

## Establishment



## Xenon Lamp



## UV Fluorescent Lamp



## Metaling™ Lamp



# 1920 Foundation

1937 Development of Temperature and Humidity Chamber  
1949 Incorporated Under the Name "Toyo Rika Kogyo Instruments Co., Ltd."

# 1952 Development of Carbon Arc Weather Meter

1958 Participating in ISO/TC38 (Textiles)

# 1959 Development of Xenon Weather Meter

# 1959 Development of Sunshine Weather Meter

1961 Participating in ISO/TC61(Plastic)  
1974 Company Name Changed to "Suga Test Instruments Co., Ltd."  
1974 Participating in ISO/TC107 (Metallic and other inorganic coatings)  
1977 Participating in ISO/TC79(Aluminum)  
1980 Completion of Hidaka Laboratory  
1981 Establishment of Suga Weathering Technology Foundation

# 1982 Development of Fluorescent Weather meter

1984 ISO 2135 SUGA listed  
1984 ISO 105B SUGA listed  
1985 Participating in ASTM G03 (Weathering), D01(Paint)  
1987 AATCC TM 169 SUGA listed  
1988 Completion of Xenon Lamp Factory at Hidaka Factory  
1988 Participating in ISO/TC156 (Metal)  
1988 Participating in SAE

# 1993 Development of Metaling™ weather meter

1995 ASTM G26 (Xenon arc) SUGA listed  
1995 ASTM G53 (UV Fluorescent Lamp) SUGA listed  
1996 ISO 9001 Certified  
1997 ASTM G23 (Carbon arc) SUGA listed  
1997 Participating in ISO/TC45 Japan (Rubber material)

# 1998 Development of Metaling™ Vertical Weather Meter

2000 Accreditation by the Japanese Government as a JCSS Optical Laboratory (ISO/IEC 17025 Certification)  
2002 Accreditation by the Japanese Government as a JNLA Testing Laboratory (ISO/IEC 17025 Certification)  
2005 Participating in CIE/TC2-17 (Spectral Distribution of Simulated Solar Radiation)  
2008 Completion of Hidaka/Kawagoe Factory  
2008 Participating in ISO/TC42 Photography, Image permanence of photographic material  
2011 ISO/IEC 17025 Accreditation Laboratory (MRA, JCSS)  
2012 Opening of the Suga Europe Office  
2012 Completion of Suga Open Lab at AGFA  
2013 Participating in IEC/TC104 (Environmental test)  
2014 Awarded to Global Niche Top Companies Selection 100 by METI  
2015 Secretary of ISO/TC107 (Metallic and other inorganic coatings)/SC7(Corrosion tests)  
2016 Accreditation by ANAB, ISO/IEC 17025 Calibration (radiometer, platinum resistance thermometer sensor, pressure gauge)  
2017 CIE/TC2-88 (Standard Reference Solar Spectra for Industrial Applications) Chairman

●ANAB : ANSI ASQ National Accreditation Board  
●Metaling™ is the registered trademark by SUGA TEST Instruments.

## UV Carbon Arc

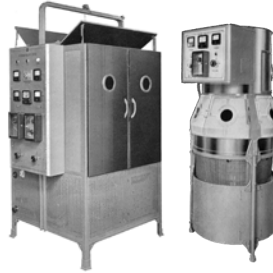

## Sunshine Carbon Arc



## Metaling™ Lamp





## Everything surround us is fated to deteriorate by being under natural environmental conditions

Have you seen anything like this before in a town?

These are examples of deterioration by sun light, heat, water, etc.



## Weatherability

Weatherability is defined by JIS D 0205 "Test Method of Weatherability for Automotive Parts" as follows; Resistivity against deteriorations mainly due, among the natural environments, to sunlight, rain and snow, temperature, humidity and ozone.

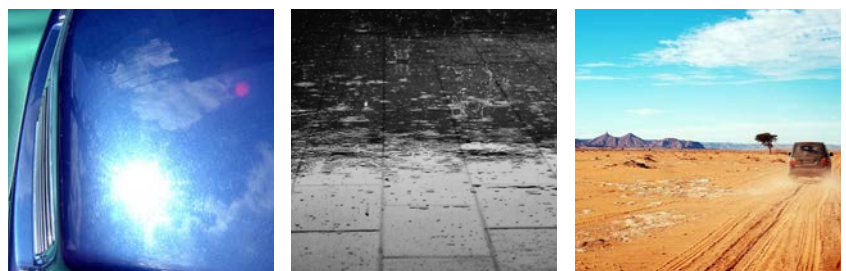
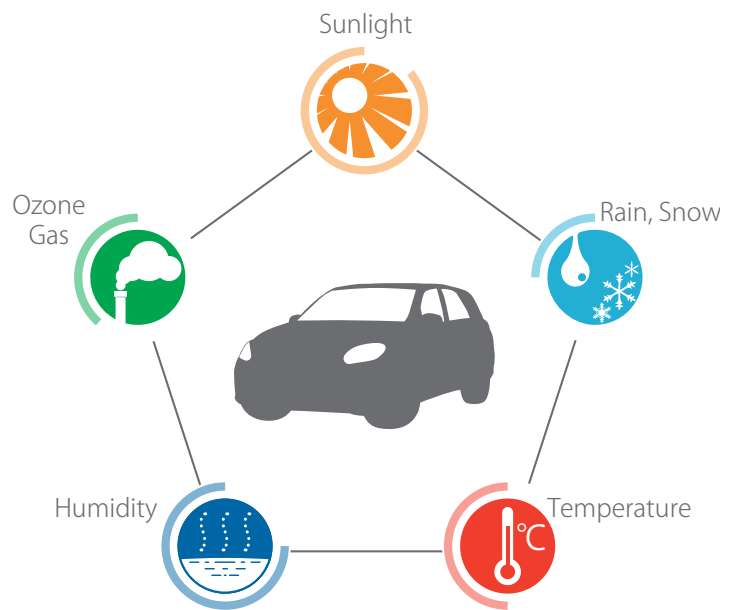

# Weathering test instruments can predict lifespan and quality of products/materials faster and more accurately

## Advantages of accelerated weathering test

It is possible to shorten testing time compare to outdoor exposure test

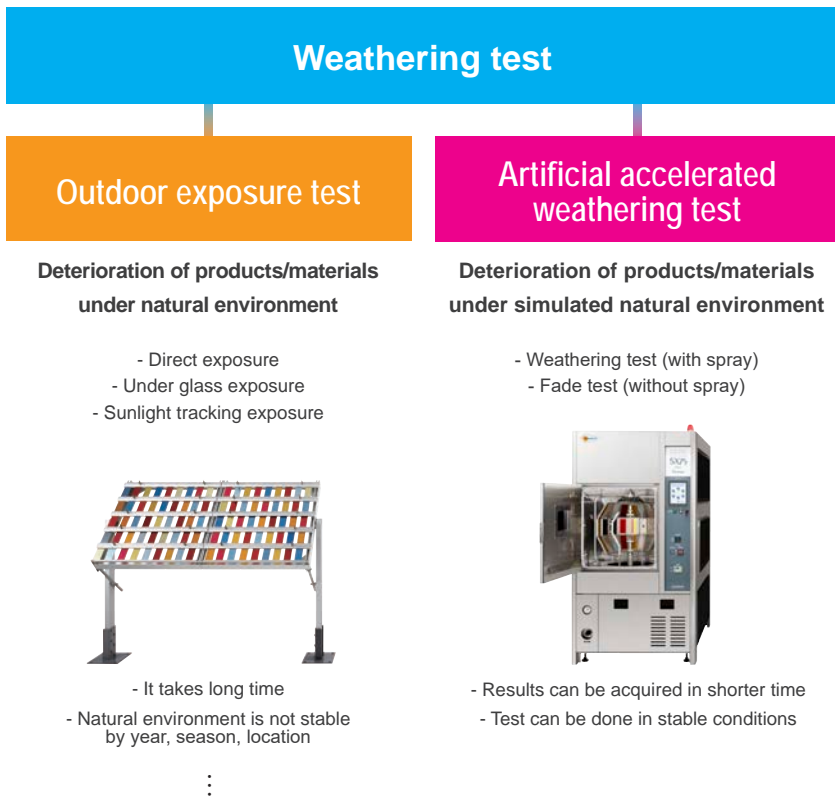

## Methods of accelerated weathering test

### Using a method specified in standard

International standards (ISO, IEC), industrial standards, in-house standards are established by each products or materials.

### Standardized industries

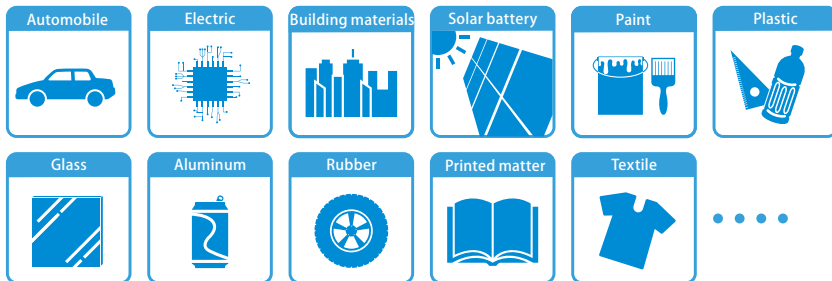

ISO: International Organization for Standardization, IEC: International Electrotechnical Commission, ASTM: ASTM International, SAE: Society of Automotive Engineers, JIS: Japanese Industrial Standards, JASO: Japanese Automotive Standards Organization, AATCC: American Association of Textile Chemists and Colorists...

## Reproducibility

It is significant to reproduce natural deteriorated parameters

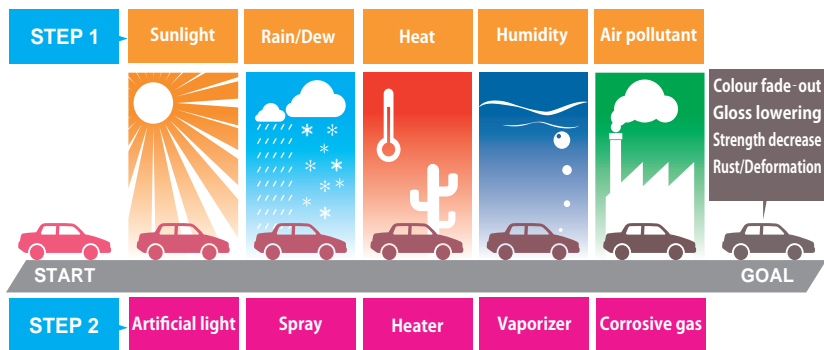

# Light source line up for all tests/standards

All of the light source for weathering test/standards in different industries are produced.

## Xenon Lamp

(P11 to 14, P20)



This light source is very close to solar spectral irradiance range from ultra violet to visible light. Long arc lamp which ignition electrode distance is long irradiates uniform light to wide range specimen surface. High irradiance test (180W/m<sup>2</sup>) is possible by holding specimens closer to light source keeping correlation with outdoor exposure test. Various test conditions are possible by combination of filters. (P7)

Spectral irradiance data of Xenon lamp

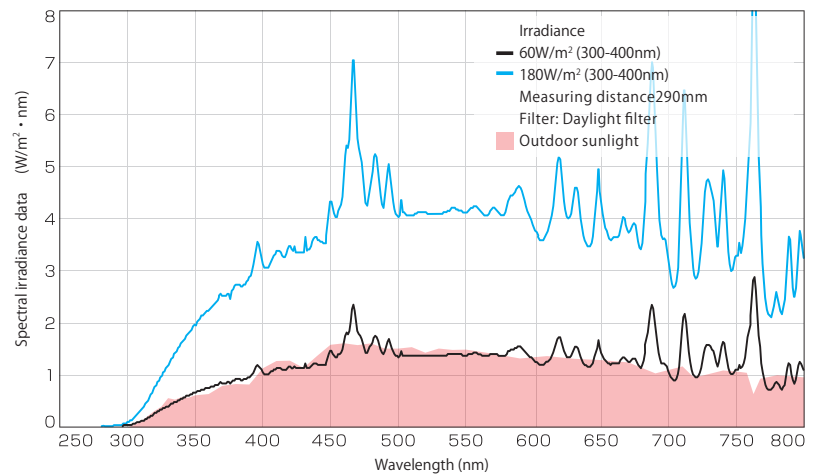

## Sunshine Carbon Arc Lamp (P17)



This light source has close to 350nm ascent of solar, strong energy from 350 to 430nm, and trusted around the world 80 years with plenty stored data. Specified in many standards including ISO, its test results have contributed to the technological development of various products and materials.

Spectral irradiance data of Sunshinecarbon arc lamp

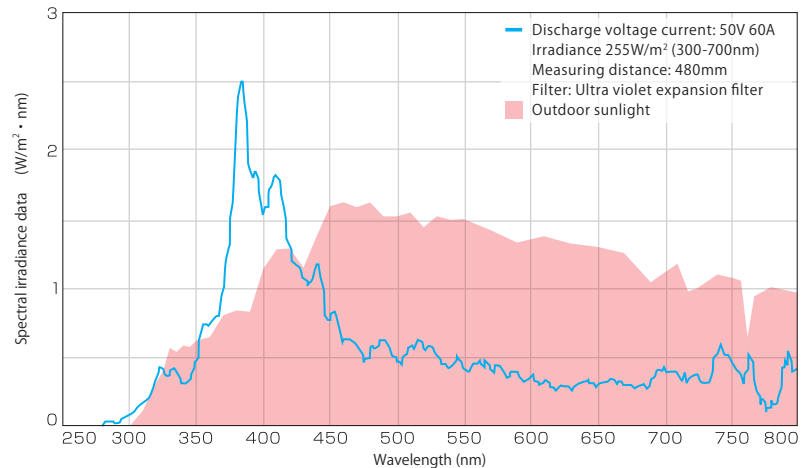

## UV Fluorescent Lamp

(P18)



This has energy on UV part only and used for UV deterioration. Various test conditions can be applied by exchanging lamp. FS-40 lamp (UVB 313 lamp) has energy peak in 313nm and deteriorate strongly by wavelength not reaching ground surface. UVA 315 lamp simulates day light through window glass.

Spectral irradiance data of UV Fluorescent lamp

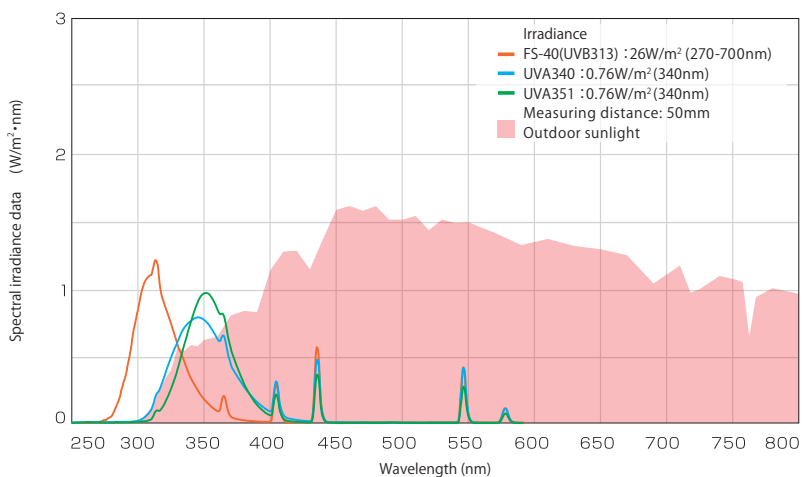

### Metaling™ Lamp

(Vertical lamp type) (P15)



This metal halide light source has UV energy more than 8times compare to sun light. Vertical lamp type is SUGA exclusively developed lamp to have same structure with other weather meter that has proper control performance. In recent years, demand of super accelerated weathering test is getting increased in order to shorten development period or guarantee long-term life warranty. Various test conditions are possible for combination of filters.(P8)

Spectral irradiance data of vertical lamp type Metaling™ lamp

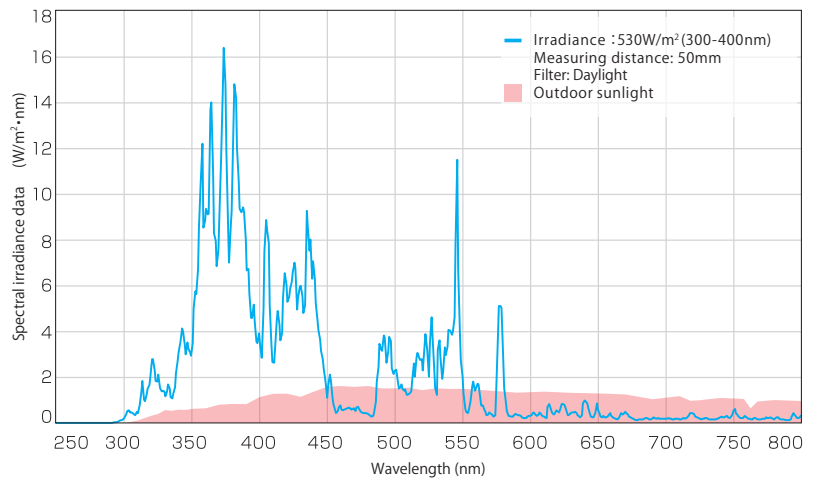

### Metaling™ Lamp

(Horizontal lamp type) (P16)

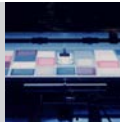

This metal halide light source has UV energy more than 20 times compare to sun light. In recent years, demand of super accelerated weathering test is getting increased in order to shorten development period or guarantee long-term life warranty. Various test conditions are possible for combination of filters.(P8)

Spectral irradiance data of horizontal lamp type Metaling™ lamp

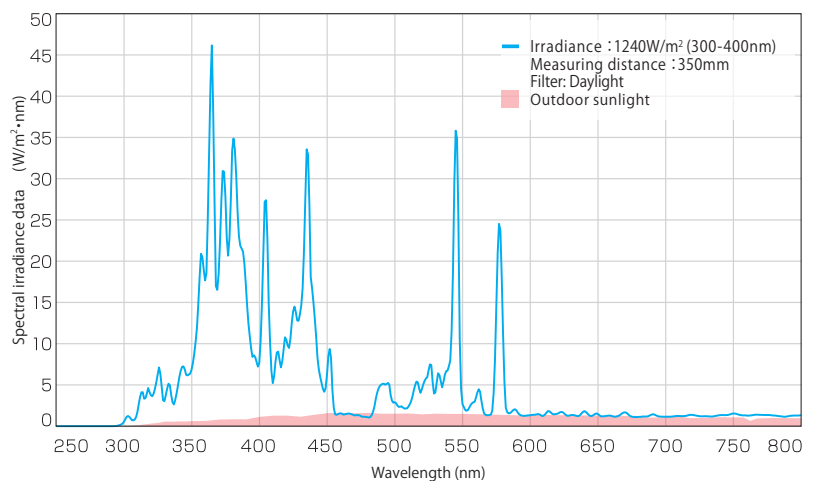

### UV Carbon Arc Lamp

(P19)

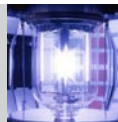

This light source has strong UV energy (close to 386nm) that is different from sunlight Spectral irradiance data. And this is the oldest light source with plenty stored data. This has been used widely as color fastness to light of textiles, anodic oxidation coatings, interior building materials, daily products such as writing materials.

Spectral irradiance data of UV carbon arc

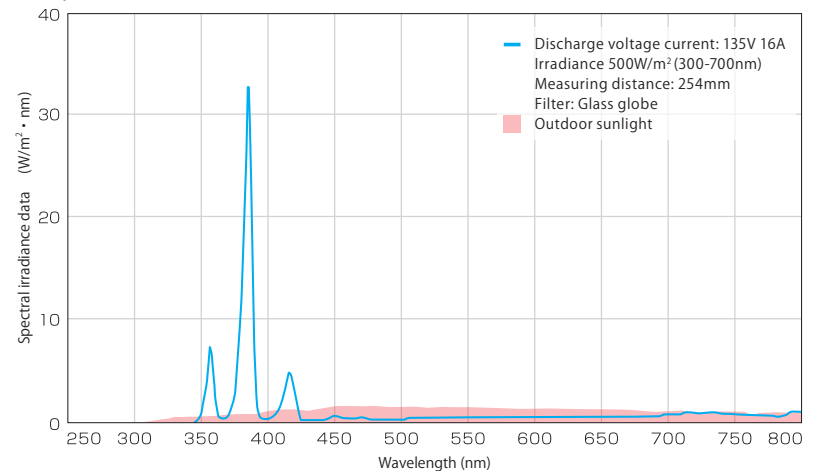

Other light sources such as mercury lamp or fluorescent lamp are available.

# Various sunlight simulation by filter combination

Various sunlight can be simulated by selecting filter, Daylight filter for outdoor sunlight, Window glass filter for indoor sunlight through glass window, etc.

## Xenon lamp

### Outdoor sunlight simulation Daylight filter

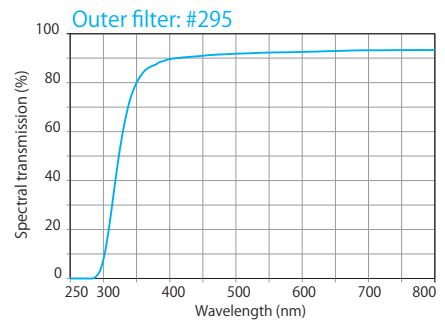
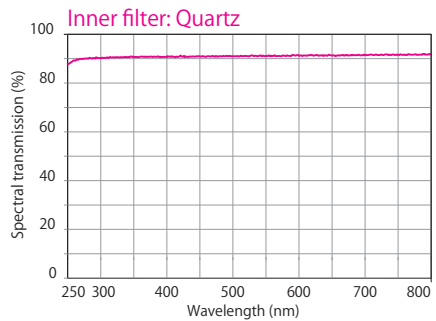

### Indoor sunlight through window glass simulation Window glass filter

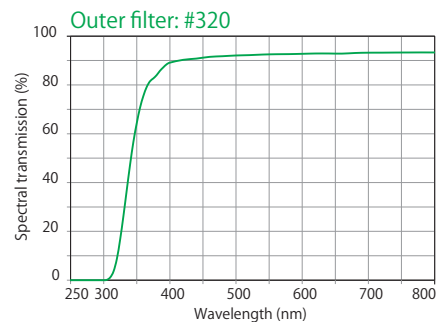
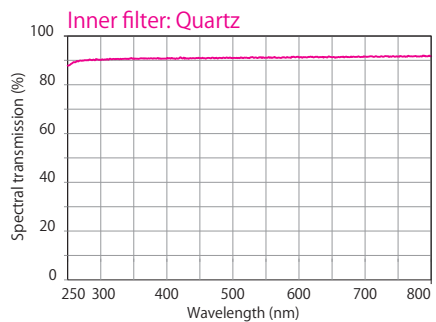

### UV energy expand compare to outdoor sunlight UV expanded filter

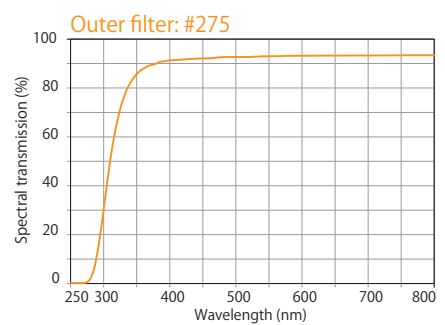
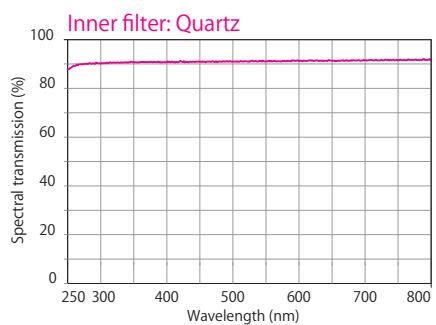

Other filter such as infrared light (IR) cut filter or UV cut filter (#350) are available.

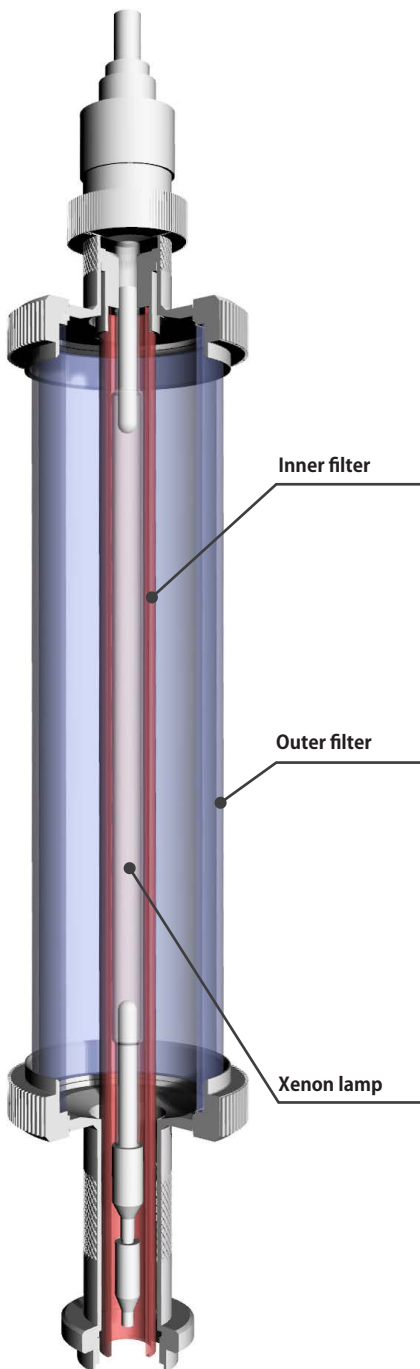

### The lamp is the essence of weather meter All parts are manufactured in-house

Optimum lamps for weather meters are manufactured and developed by integrated production system from high-purity processing of electrode to quartz piping under thorough quality control. Sunshine carbon arc or UV carbon arc are manufactured as original design.



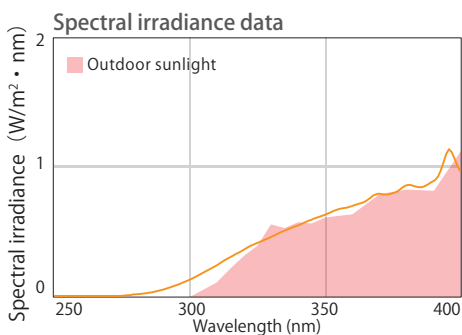
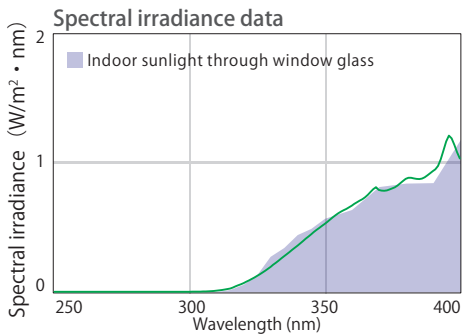
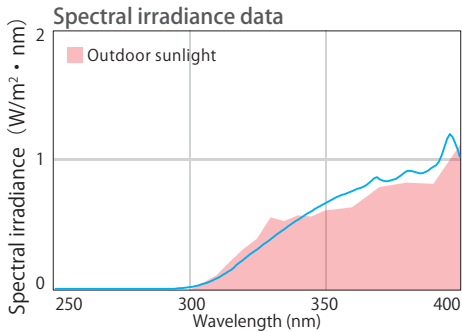

**Metaling™ lamp (vertical lamp type)**

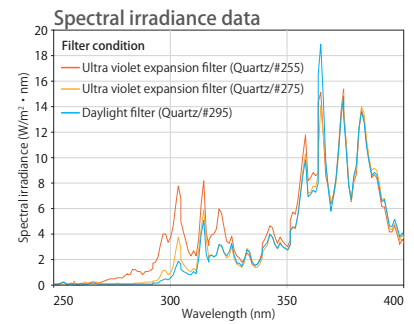
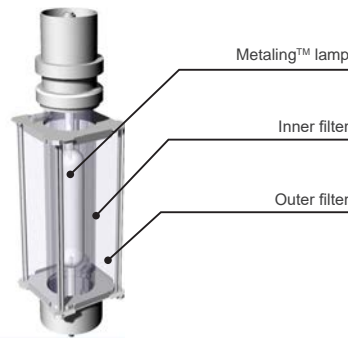

**Metaling™ lamp (horizontal lamp type)**

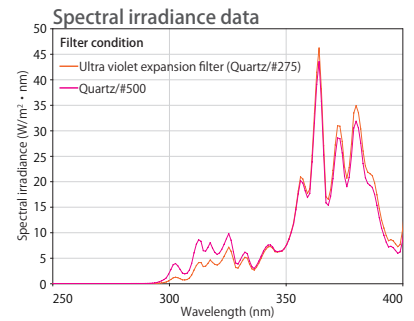
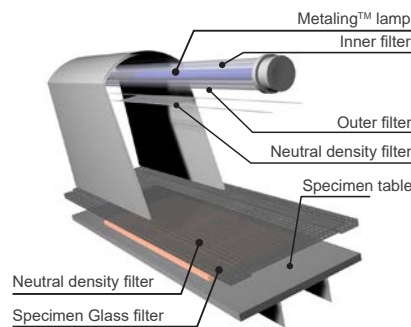

**Sunshine carbon arc lamp**

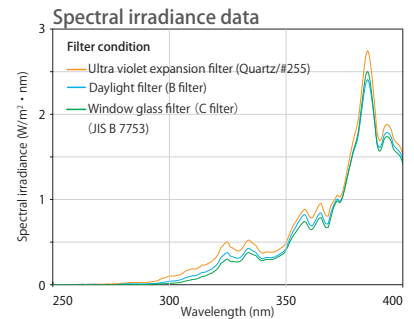
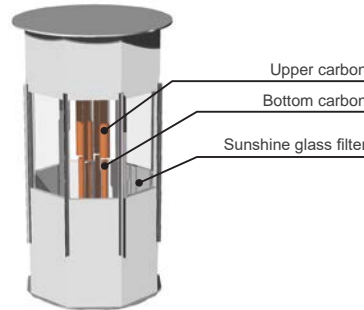

**UV carbon arc lamp**

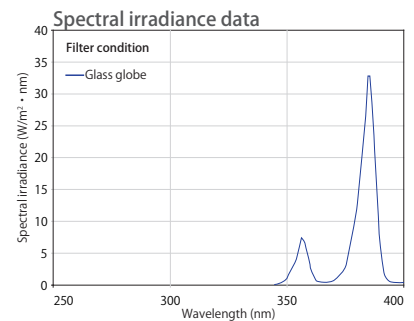
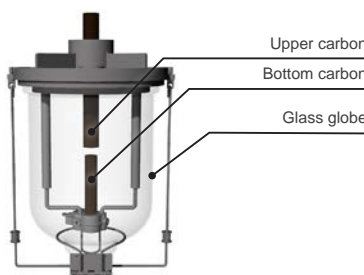

**Originally designed ignition circuit for stable light/discharge**

Ignition circuit of of originally designed combination (igniter, reactor, transformer, etc.) supports stable lighting/discharge.



# Configuration

(Example of Xenon weather meter)

Test chamber is configured by lamp to simulate natural environment, specimen spray, backside spray, measurement device for temperature/humidity, and specimen rotating device for exposure of uniform conditions on the specimens. Specimen holder mounted to the Specimen rack has various sensors, such as irradiance of specimen surface, temperature, etc.

**Automatic irradiance control**  
**Automatic black panel temperature control**

**Attached to same position with specimen surface**

Light receptor and BPT(BST) sensor attached to specimen rack, measure and control the irradiance and BPT(BST), while rotating at same position with specimen surface.

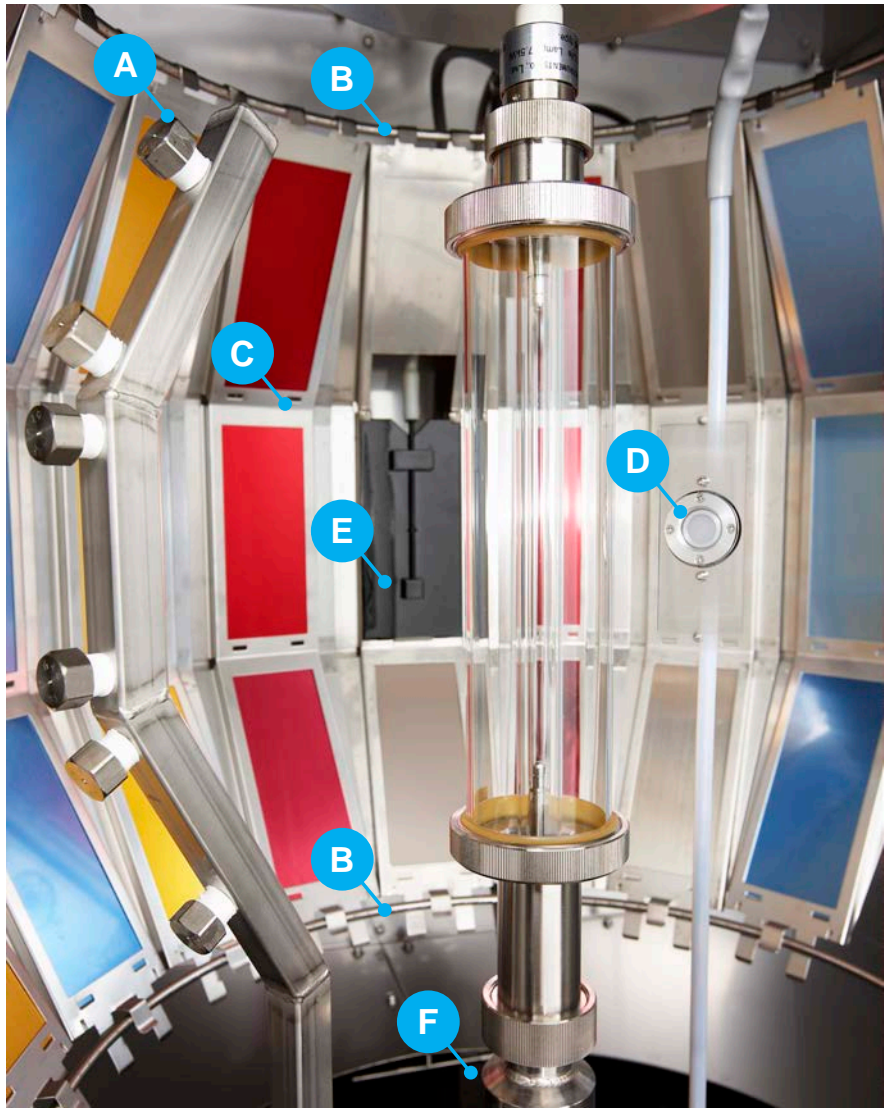
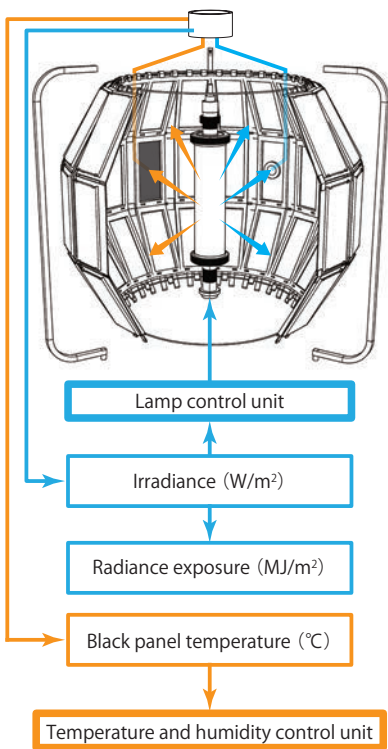

**A Specimen spray**

Water sprays on the specimen surface uniformly. For more accurate test, spray water temperature controller is available as option (P22). Back side spray on the specimen can occur dew on the specimen surface.

**B Specimen rack**

For exposure specimens to test conditions uniformly, mounted specimen holders turns around the light source. Specimen rack speed (rpm) is changed as option.

**C Specimen holder (P22)**

3 in one specimen holder (upper/middle/lower position) prevents light leakage and reduces disturbance of airflow on the specimen surface.



**D Light receptor**

Irradiance from light source is measured at specimen surface. Measurement wavelength is 300 to 400nm as standard, and 340nm,420nm,290 to 800nm,300 to 700 nm,etc. are available as option.

**E Black panel sensor**

It shows maximum temperature of specimen by the sum of radiant heat from light source and chamber air temperature. Both of black panel temperature control and chamber air temperature control can be used simultaneously.

**F Platinum resistance thermometer**

(Chamber air temperature sensor)

The sensors to measure dry/wet bulb temperature in the chamber. The sensors are placed where exposed no direct light.

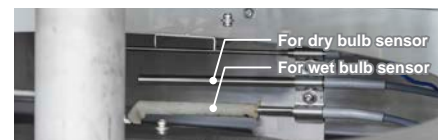

# Temperature/Humidity control (Case of Xenon weather meter)

Temperature/Humidity control inside Test chamber is important to test accurately. There are two methods to do optimal temperature/humidity control.

## Outside air intake type

Test chamber temperature and humidity are controlled by SUGA Air Blender™ that controls air valve of outside air intake and heater. Wider and more stable temperature and humidity range is capable by using optional humidity unit. This humidity unit supplies pre-conditioned temperature and humidity air to the plenum space from outside air. Humidifier is a vaporizing humidifier type that prevents water splash and water stain. Optimal temperature and humidity control is capable with outside air intake by control mode.

Structure

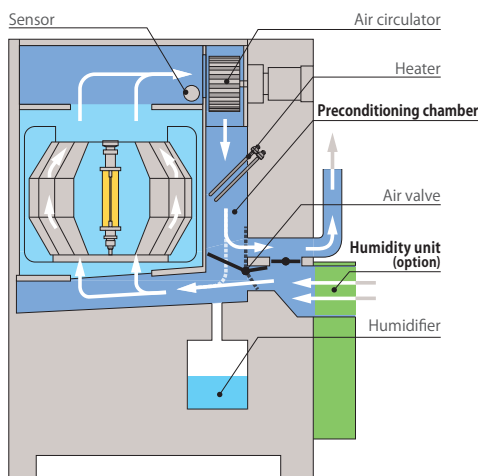

## Example of temperature and humidity range

(Xenon weather meter : GX75 type)

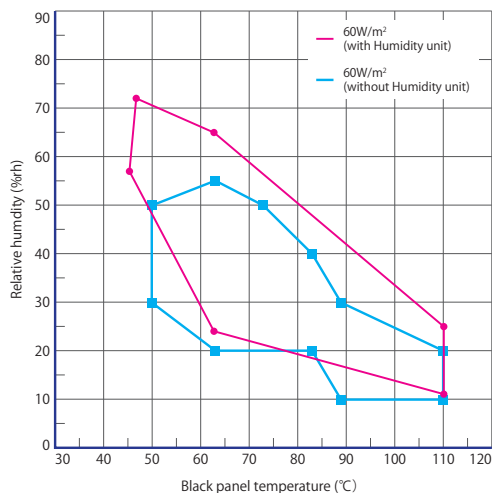

## Closed circulation type

Closed circulation type can controls temperature and humidity with refrigerator, and there is no influence by outside air conditions of installation place. Originally developed saving energy inverter system is adopted. Optimal temperature and humidity control is capable with outside air intake by control mode.

Structure

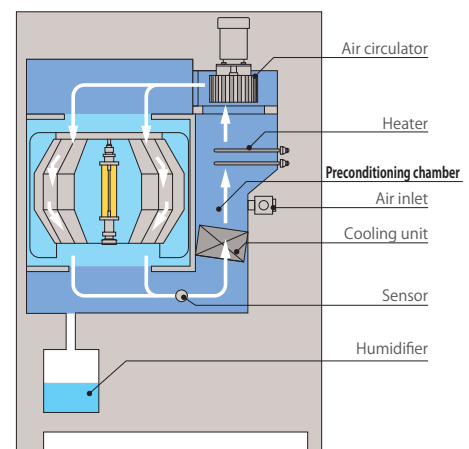

## Example of temperature and humidity range

(Super Xenon weather meter : SX75 type)

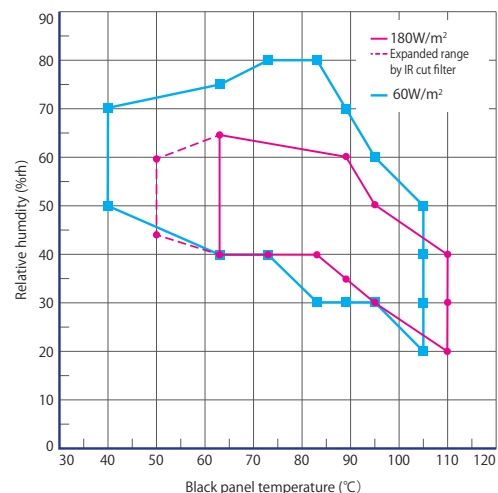

**Black-standard thermometer (BST) or black-panel thermometer (BPT) is available.**

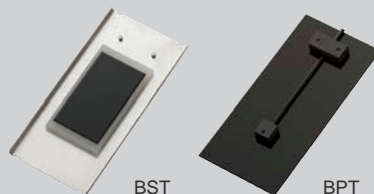

## Comparison of BPT and BST

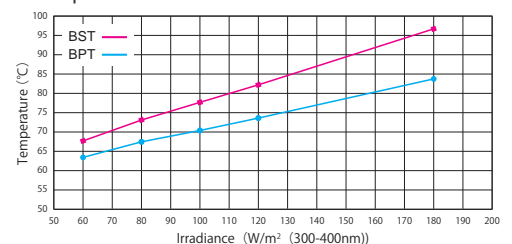

The temperature and humidity control range varies depending on the usage time and type of lamp filter, the type of test specimen, the type of weather meter, and the temperature and humidity of the installation location.

# SX75

Closed circulation type CE Marking(SX75CE)

Super Xenon™ applied for wide variety of industries

<b>Maximum Irradiance</b> <b>180</b> W/m <sup>2</sup> <small>(300-400nm)</small>	<b>Specimens</b> <b>51</b> pcs. <small>(Dimensions 150×70×1mm)</small>	<b>Light</b> <b>50 to 95</b> ±1°C <small>(BPT)</small> <b>50 to 60</b> ±5%rh <small>(at BPT63°C, 180W/m<sup>2</sup>)</small>	<b>Dark</b> <b>38</b> ±1°C <small>(CAT)</small> <b>95</b> ±5%rh
--	--	--	--



Joint research with automobile manufacturer  
Adopted widely to International Standards

Faster test results by 3 times of solar ultraviolet high irradiance

Good reproducibility without outside air conditions

Side view

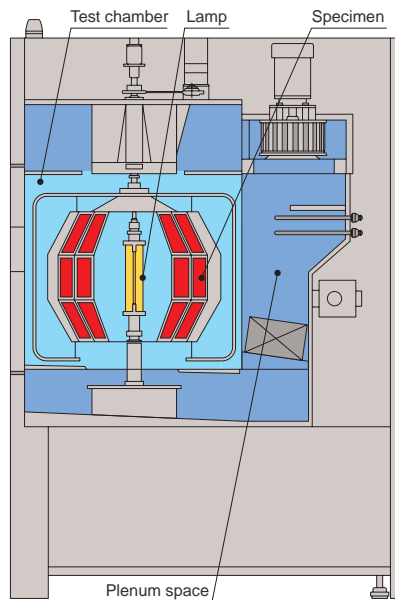

### Test result comparison of poly carbonate (PC, without surface treatment)

BPT 63°C, Humidity 50%rh, Light 102min/Light+rain 8min

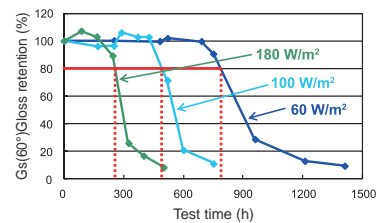

Test time(h) to 80% of gloss retention is 800:500:270, about 3:2:1.

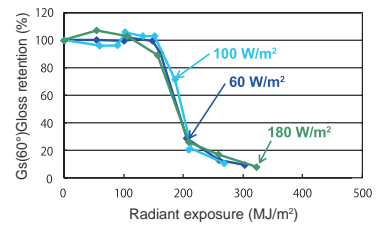

Change of gloss retention approximates compared by radiance exposure.

### Typical test standards for high irradiance xenon test

Industry	Standard	Specified irradiance	
		Daylight filter	Window glass filter
Plastic	ISO 4892-2 (JIS K 7350-2)	60W/m <sup>2</sup> or 180W/m <sup>2</sup>	50W/m <sup>2</sup> or 162W/m <sup>2</sup>
Paint	ISO 16474-2 (JIS K 5600-7-7)	60W/m <sup>2</sup> to 180W/m <sup>2</sup>	50W/m <sup>2</sup> to 162W/m <sup>2</sup>
	ASTM D6695	180W/m <sup>2</sup>	-
Non-metal materials	ASTM G155	180W/m <sup>2</sup>	162W/m <sup>2</sup>
Rubber	ISO 4665 (JIS K 6266)	60W/m <sup>2</sup> or 180W/m <sup>2</sup>	50W/m <sup>2</sup> or 162W/m <sup>2</sup>
Automobile	JASO M 346	-	50W/m <sup>2</sup> to 162W/m <sup>2</sup>
	JASO M 351	60W/m <sup>2</sup> to 180W/m <sup>2</sup>	-
Aluminum	ISO 2135 (JIS H 8685-1)	60W/m <sup>2</sup> to 180W/m <sup>2</sup>	-
Railway	JIS E 4037	60W/m <sup>2</sup> to 180W/m <sup>2</sup> (Exterior test)	50W/m <sup>2</sup> to 162W/m <sup>2</sup> (Interior test)
	ISO 105-B06 / ISO 105-B10	-	45W/m <sup>2</sup> to 60W/m <sup>2</sup> , 70W/m <sup>2</sup> to 90W/m <sup>2</sup> or 162W/m <sup>2</sup>
Textiles	JIS L 0843	-	Method A : 50W/m <sup>2</sup> , Method B: 162W/m <sup>2</sup>
	JIS L 0891	60W/m <sup>2</sup> or 180W/m <sup>2</sup>	-
Safety sign	ISO 17398 (JIS Z 9107) / JIS Z 9117	60W/m <sup>2</sup> or 180W/m <sup>2</sup>	-

•Maximum Irradiance depends on how long the lamp/filter has been used and the type of specimen.

# SX120 Closed circulation type

<b>Maximum Irradiance</b> <b>160</b> W/m <sup>2</sup> <small>(300-400nm)</small>	<b>Specimens</b> <b>105</b> pcs. <small>(Dimensions 150x70x1mm)</small>
<b>Light</b> <b>63 to 95</b> ±1°C <small>(BPT)</small> <b>40 to 60</b> ±5%rh <small>(at BPT63°C, 160 W/m<sup>2</sup>)</small>	<b>Dark</b> <b>38</b> ±1°C <small>(CAT)</small> <b>95</b> ±5%rh



Large model to test a large quantity of specimens at a time

•A model with even higher illuminance is also available (specimen rotating frame φ 780mm).

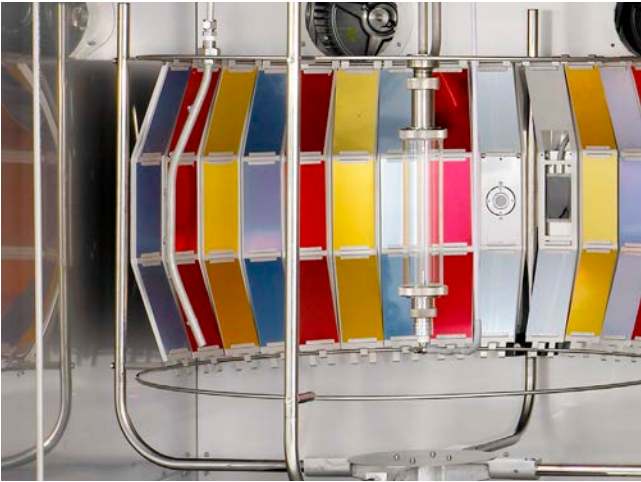

### Long arc lamp irradiates wide range uniformly

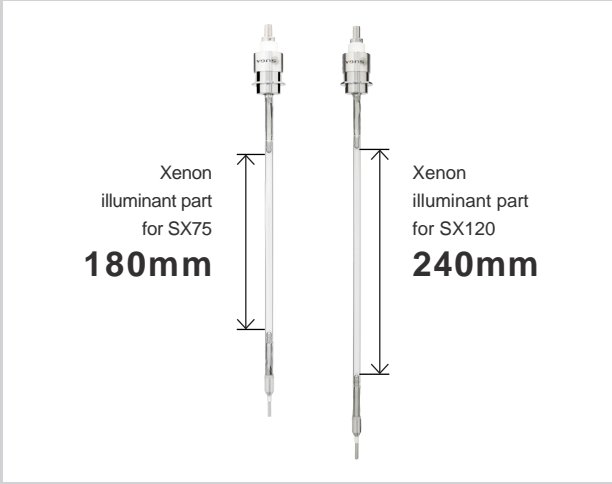

•Maximum Irradiance depends on how long the lamp/filter has been used and the type of specimen.

# SX75-2D Closed circulation type

<b>Maximum Irradiance</b> <b>180</b> W/m <sup>2</sup> <small>(300-400nm)</small>	<b>Specimens</b> <b>102</b> pcs. <small>51 pcs. x 2 chambers (Dimensions 150x70x1mm)</small>
<b>Light</b> <b>50 to 95</b> ±1°C <small>(BPT)</small> <b>50 to 60</b> ±5%rh <small>(at BPT63°C, 180 W/m<sup>2</sup>)</small>	<b>Dark</b> <b>38</b> ±1°C <small>(CAT)</small> <b>95</b> ±5%rh



Independent 2 chambers with separate test and test a large quantity of specimens at a time

Example of separate test

Test for automobile exterior with spray

Test for automobile interior without spray

### Space-saving design

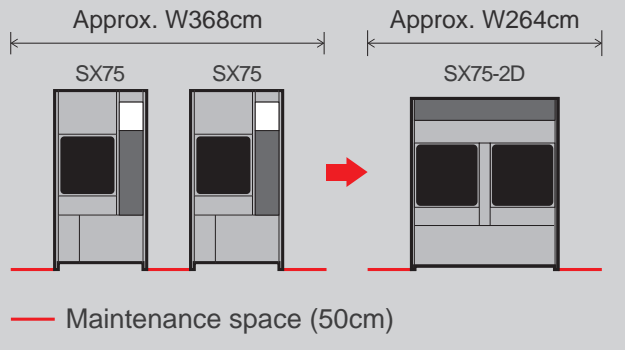

# GX75

Outside air intake type

CE Marking(GX75CE)

World wide model applied for wide standards



Maximum Irradiance

**120** W/m<sup>2</sup>  
(300-400nm)

Specimens

**60** pcs.  
(Dimensions 150×70×1mm)

Light

**63 to 110** ±2°C  
(BPT)  
**50** ±5%rh  
(at BPT63°C, 60W/m<sup>2</sup>)

Dark

**38** ±2°C  
(CAT)  
**95** ±5%rh

Side view

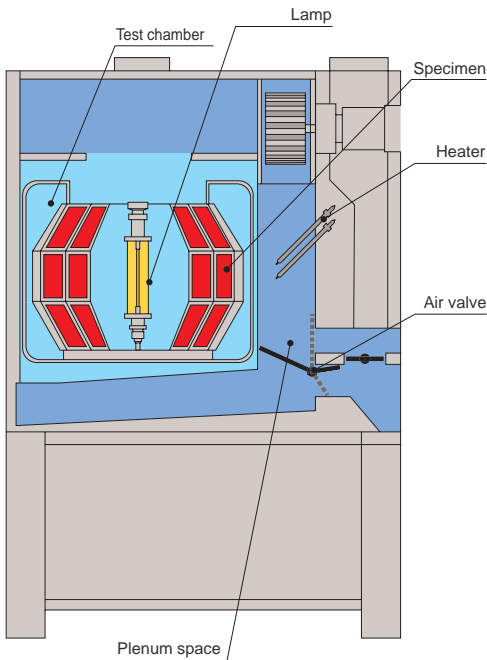

High irradiance weather meter applied

## SUGA Air Blender™

Saving energy by temperature and humidity control system

Performance check by polystyrene standard specimen

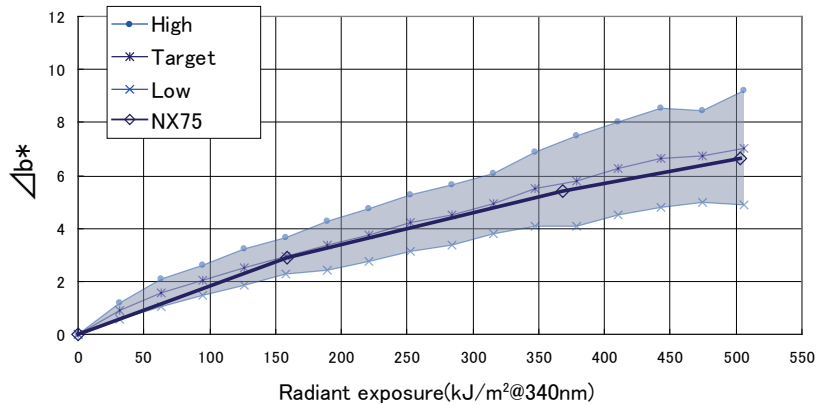

## Eco Unit for energy saving

By installing the eco unit (EU-NX type), the outside air intake time (opening time of the air control valve) is reduced, suppressing fluctuations in the temperature and humidity inside the test chamber due to outside air. This reduces the ON time of the air heater and the ON time of the humidity generator heater, thereby reducing power consumption and water consumption. Also, the temperature and humidity control range is expanded (see P10).

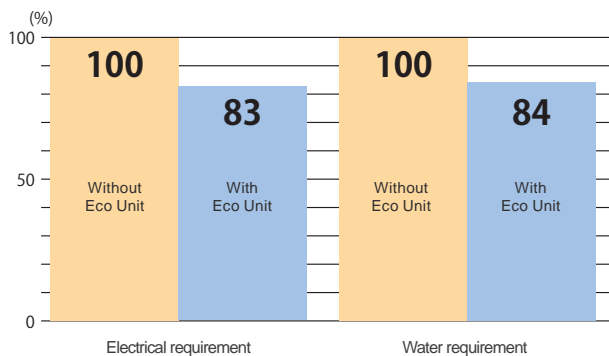

•Maximum Irradiance depends on how long the lamp/filter has been used and the type of specimen.



Eco unit on the GX75 back side.

## X75 Outside air intake type CE Marking(X75CE)

<b>Maximum Irradiance</b> <b>70</b> W/m <sup>2</sup> <small>(300-400nm)</small>	<b>Specimens</b> <b>105</b> pcs. <small>(Dimensions 150x70x1mm)</small>
<b>Light</b> <b>63 to 83</b> ±2°C <small>(BPT)</small>	<b>Dark</b> <b>38</b> ±2°C <small>(CAT)</small>
<b>30 to 60</b> ±5%rh <small>(at BPT63°C, 60 W/m<sup>2</sup>)</small>	<b>95</b> ±5%rh



General-purpose chamber tests a large quantity of specimens at a time

## GX25 Outside air intake type

<b>Maximum Irradiance</b> <b>60</b> W/m <sup>2</sup> <small>(300-400nm)</small>	<b>Specimens</b> <b>96</b> pcs. <small>(Dimensions 65x55x1mm)</small>
<b>Light</b> <b>63 to 110</b> ±2°C <small>(BPT)</small>	<b>Dark</b> <b>38</b> ±2°C <small>(CAT)</small>
<b>35 to 60</b> ±5%rh <small>(at BPT63°C, 42 W/m<sup>2</sup>)</small>	<b>95</b> ±5%rh



Indoor products model without spray

## X75L Closed circulation type

<b>Maximum Irradiance</b> <b>70</b> W/m <sup>2</sup> <small>(300-400nm)</small>	<b>Specimens</b> <b>105</b> pcs. <small>(Dimensions 150x70x1mm)</small>
<b>Light</b> <b>12 to 80</b> ±2°C <small>(CAT)</small>	<b>Dark</b> <b>5 to 80</b> ±1°C <small>(CAT)</small>
<b>30 to 70</b> ±5%rh <small>(at BPT63°C, 60 W/m<sup>2</sup>)</small>	<b>95</b> ±5%rh <small>(at CAT38°C)</small>



Low temperature cycle model with refrigerator

## X25A Outside air intake type

<b>Maximum Irradiance</b> <b>60</b> W/m <sup>2</sup> <small>(300-400nm)</small>	<b>Specimens</b> <b>38</b> pcs. <small>(Dimensions 65x55x1mm)</small>
<b>Light</b> <b>63</b> ±2°C <small>(BPT)</small>	<b>Dark</b> <b>38</b> ±2°C <small>(CAT)</small>
<b>35 to 60</b> ±5%rh <small>(at BPT63°C, 42 W/m<sup>2</sup>)</small>	<b>95</b> ±5%rh



Air cooled lamp model



•Maximum Irradiance depends on how long the lamp/filter has been used and the type of specimen.

# MV3000

Closed circulation type

Ultra accelerated weather meter with same structure as the conventional models



Maximum Irradiance

**580** W/m<sup>2</sup>  
(300-400nm)

Specimens

**13** pcs.  
(Dimensions 150x70x1mm)

Light

**63 to 85** ±1°C  
(BPT)  
**50** ±5%rh  
(at BPT63°C)

Dark

**30 to 50** ±1°C  
(CAT)  
**95** ±5%rh  
(at CAT 38°C)

Side view

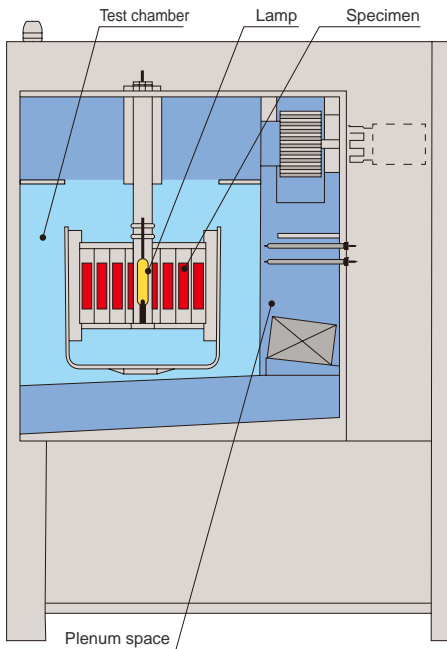

Originally-developed vertical lamp type to irradiate specimens uniformly (US. Pat. 6,591,701)

PP surface observation (clack)

	Before test	2 years (600MJ/m <sup>2</sup> )	3 years (900MJ/m <sup>2</sup> )
Outdoor exposure (Shinjuku)			
High irradiance Xenon (SX75) 180 W/m <sup>2</sup> (300-400nm)		957h (620MJ/m <sup>2</sup> ) 	1235h (800MJ/m <sup>2</sup> ) 
MV3000 530 W/m <sup>2</sup> (300-400nm)		262h (500MJ/m <sup>2</sup> ) 	440h (840MJ/m <sup>2</sup> ) 

Comparable with conventional weather meter

MV3000

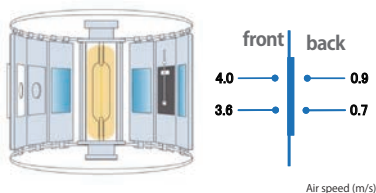

SX75

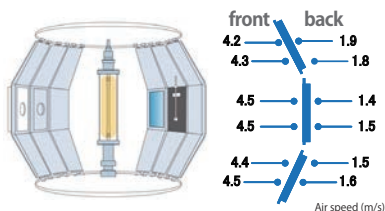

Performance check by polystyrene standard specimen

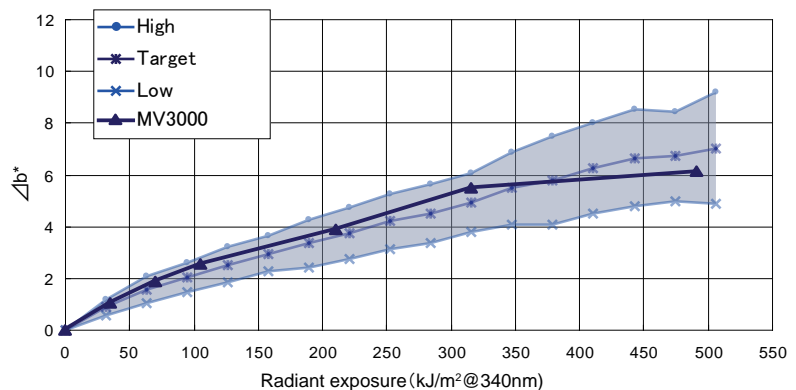

•Maximum Irradiance depends on how long the lamp/filter has been used and the type of specimen.



# M6T

Closed circulation type

Ultra accelerated weather meter with strong UV irradiance

<b>Maximum Irradiance</b> <b>2.00</b> kW/m <sup>2</sup> <small>(300-400nm)</small>	<b>Effective irradiated area</b> <b>440x180</b> mm <small>(Excluding center area 50 x 115mm)</small>	<b>Light</b> <b>30 to 85</b> ±2°C <small>(BPT, at 1.24kW/m<sup>2</sup>)</small> <b>30 to 70</b> ±5%rh <small>(at BPT63°C, 1.24kW/m<sup>2</sup>)</small>	<b>Dark</b> <b>5 to 100</b> ±2°C <small>(CAT)</small> <b>50 to 95</b> ±5%rh <small>(at CAT40°C)</small>
--	--	---	---



Side view

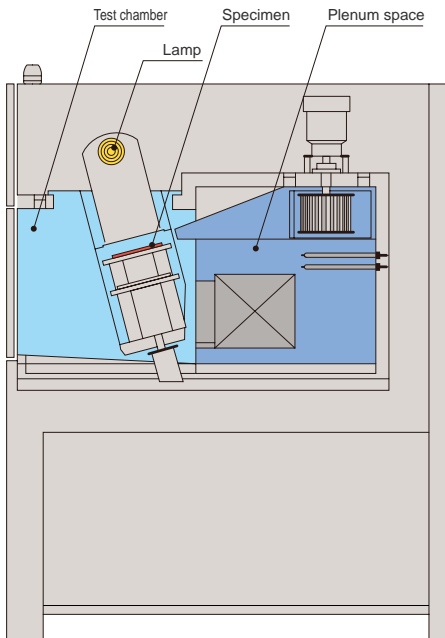

Horizontal lamp type to irradiate strong UV

High irradiance uniformity over 90%\*

Irradiance on the specimen table Upper: Irradiance Lower: BPT(°C)

1175		1201		1176
58.2		56.2		58.3
	1260		1264	
1204		1240		1220
60.6		57.9		61.3
	1236		1230	
1177		1214		1178
59.9		64.0		60.4
440mm				

Measured at 13 points (irradiance)  
 Irradiance uniformity  $\frac{1175}{1264} \times 100 \approx 93\%$

Test condition  
 Irradiance : 1240W/m<sup>2</sup> (300-400nm)  
(center of specimen table)  
 BPT : 63°C  
 Ambient condition : 27°C, 57%rh

\*Irradiance uniformity ratio (%) = minimum irradiance (W/m<sup>2</sup>)/maximum irradiance (W/m<sup>2</sup>) x 100.

Light/Rain/Dark/Dew cycle test with Temp./Humid. control

## Position of lamp and specimen

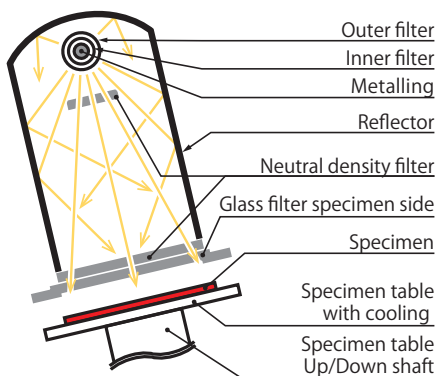

## Comparison of testing time by each light source (one example of PP)

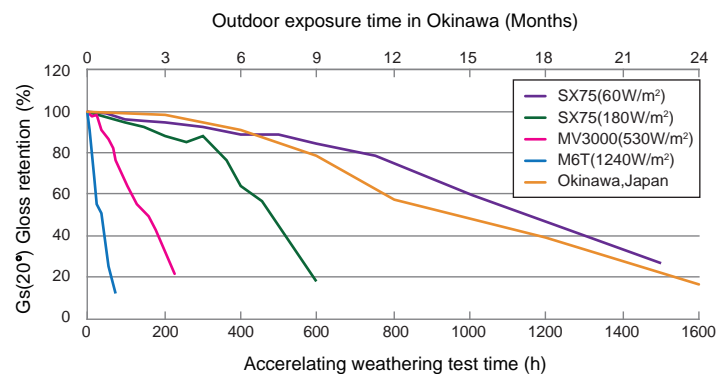

•Maximum Irradiance depends on how long the lamp/filter has been used and the type of specimen.  
 •Extreme UV energy may cause behavior different from outdoor exposure, so caution is required in test results.

# S80

Outside air intake type

## Standard model of Sunshine carbon arc weather meter

<b>Irradiance</b> <b>255</b> W/m <sup>2</sup> ±10% (300-700nm)	<b>Specimens</b> <b>70</b> pcs. (Dimensions 150×70×1mm)	<b>Continuous lighting time</b> <b>78</b> h	<b>Temp./Humid. Range</b> <b>63</b> ±3°C (BPT) <b>30 to 70</b> ±5%rh
--	---	--	---



### Side view

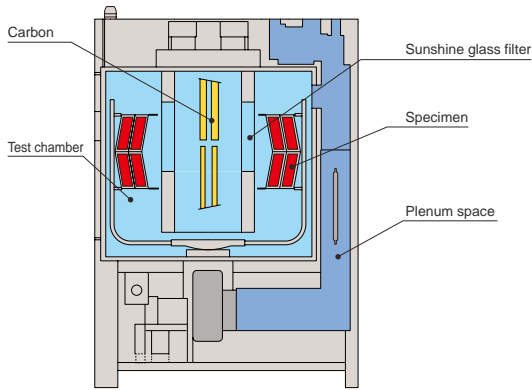

### Exhaust treatment unit SAC (option)

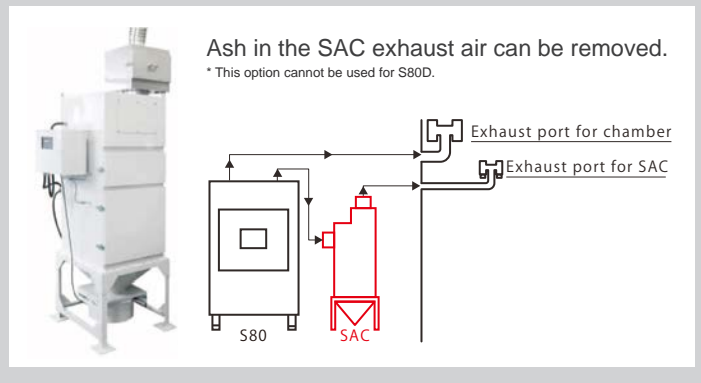

### Various models line up

## S80D

Dew cycle model

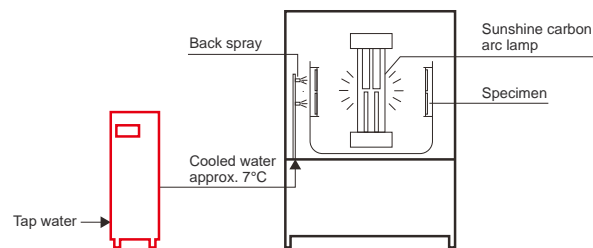

**S80L**  
CAT 17°C low temp. model

**S80H**  
BPT 95°C high temp. model

**S80B**  
BPT auto-control model

**S80BR**  
BPT record model

**S80BBR**  
BPT auto-control/record model

**S80-2D**  
Independent 2 chambers model

### Typical test standards for Sunshine Carbon Arc test

Industry	Standard					
Plastic	ISO 4892-1	ISO 4892-4	JIS K 7350-1	JIS K 7350-4		
Paint	ISO 16474-1	ISO 16474-4	ASTM D822	ASTM D3361		
Building	JIS A 1415	JIS A 1439	JIS A 5422	JIS A 5759	JIS A 6021	JIS A 6111
Printed matter and ink	JIS K 5701-1					
Textiles	AATCC TM192	JIS L 0891				
Aluminum	ISO 2135	ISO 28340	JIS H 8602	JIS H 8685-1		
Glass	JIS R 3212					
Rubber	ISO 4665	ASTM D750	JIS K 6266	JIS K 6404-17	K 6404-18	
Solar battery	JIS C 8917	JIS C 8918	JIS C 8938	JIS C 8939		
Automobile	JIS S 3107	JIS D 0202	JIS D 0205	JIS D 0208	JIS D 4604	JIS D 5500
Railway	JIS E 1203	JIS E 4037				
Packing material	JIS Z 0237	JIS Z 1528	JIS Z 1541			
No-metal material	ASTM G151	ASTM G152				
Safety sign	ISO 17398	JIS Z 9096	JIS Z 9107	JIS Z 9117		
Measuring instrument	JIS C 1271-1	JIS C 1272-1				
Apparatus	JIS B 7753					

# FUV

Outside air intake type

Simulating paint physical properties deterioration in short time

<p>Irradiance</p> <p><b>12 to 42 W/m<sup>2</sup></b> (270-700nm)</p> <p><b>0.47 to 1.48 W/m<sup>2</sup></b> (310nm)</p>	<p>Specimens</p> <p><b>48 pcs.</b> (Dimensions 150x75x1mm)</p>	<p>Temp./Humid. Range</p> <p><b>50 to 80 ±3 °C</b> (Light BPT)</p> <p><b>40 to 70 ±3 °C</b> (Dark CAT)</p>
---	--	--



Simulating paint physical properties deterioration in short time  
Experience in paint industry

Achieved irradiance uniformity by arched positioned light source

Side view

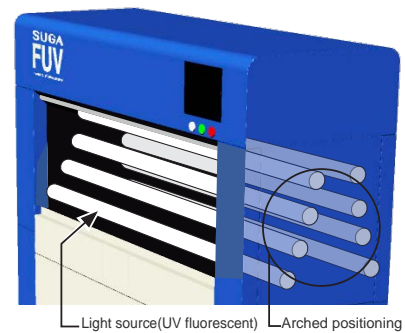
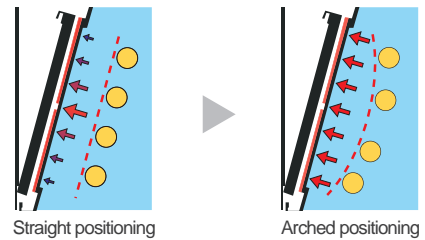
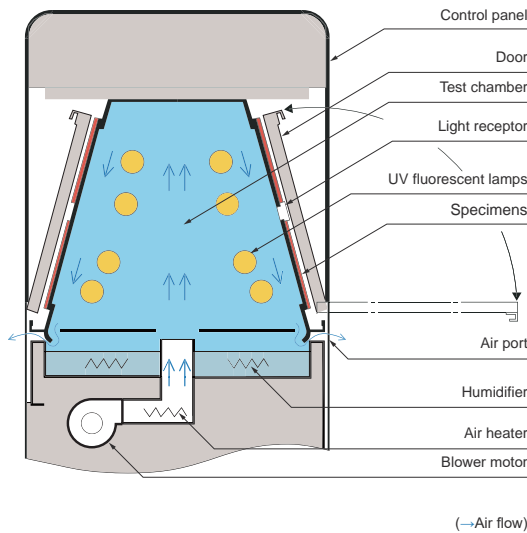

**Quick View System™**  
Quick check without taking out specimens

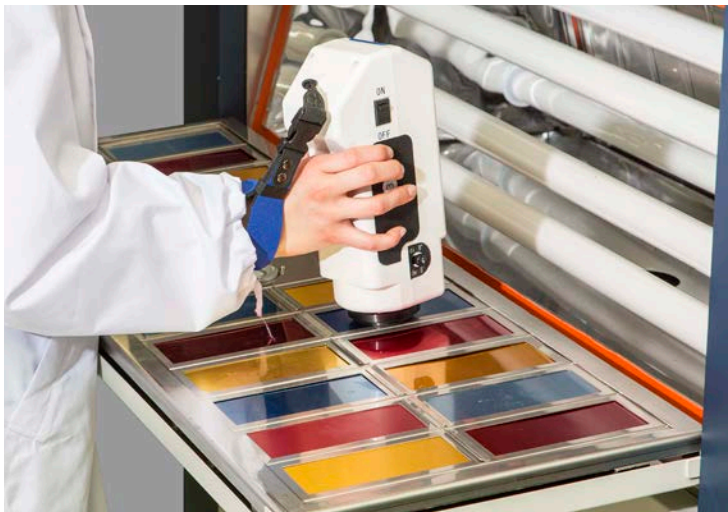

Light & Surface spray model is available.  
Model : FUV-S



# U48AU

Outside air intake type

Standard model for colour fastness of textiles

<b>Irradiance</b> <b>500</b> $\pm 100 \text{W/m}^2$ (300-700nm)	<b>Specimens</b> <b>108</b> pcs. (Dimensions 65x55x1mm)	<b>Continuous lighting time</b> <b>48</b> h	<b>Temp./Humid. Range</b> <b>63</b> $\pm 3^\circ\text{C}$ (BPT) <b>35 to 50</b> $\pm 5\%$ rh
---	---	--	---



Long-term experience in Textiles industry

Continuous lighting time 48h  
High reproducibility with stable light

Front view

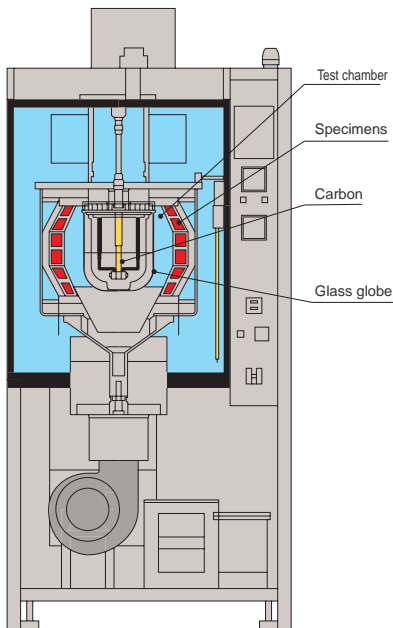

Temperature and humidity are controllable

## Models with option

**U48S**  
Low temperature model with refrigerator

**U48AUH/U48H**  
High temperature BPT95°C model

**U48AUB/U48B**  
BPT auto-control model

**U48AUBR/U48BR**  
BPT record model

**U48AUBBR/U48BBR**  
BPT auto-control/record model



Judgement of colour fastness class under the standard light source

# U48

Outside air intake type

<b>Temp./Humid. Range</b> <b>63</b> $\pm 3^\circ\text{C}$ (BPT) <b>50</b> %rh or less
--



Temperature control model with outside air intake

Front view

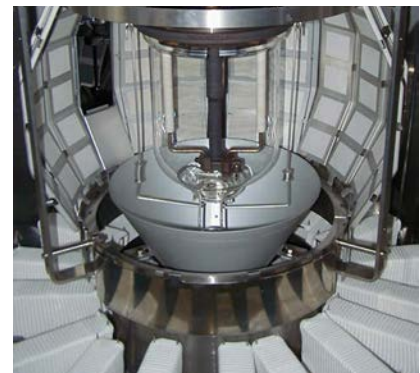
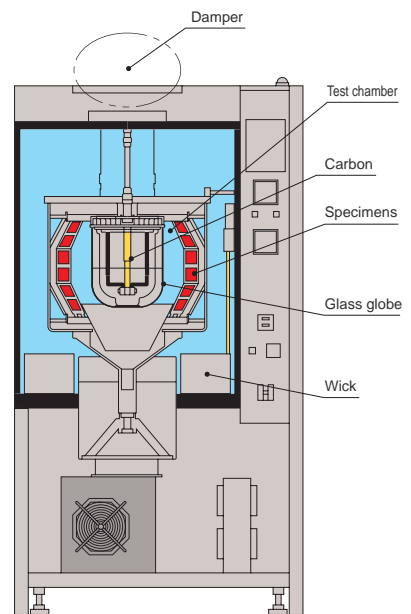

Wick at bottom of Test chamber

# XT750

Outside air intake type

## Table top type Xenon Weather meter

Irradiance  
2,000<sub>to</sub>  
30,000<sub>lx</sub>

Specimen table size  
250×250mm  
(Irradiance uniformity ±10% or less)

Temp. Range  
RT+10±2°C  
(RT:Room Temp.)



### Air cooled model (No cooled water)



Specimens on the table

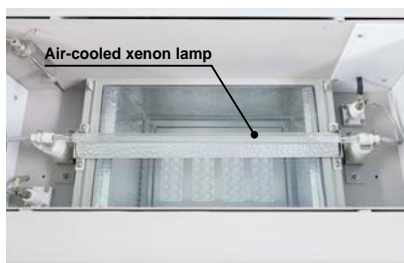

Lamp mount

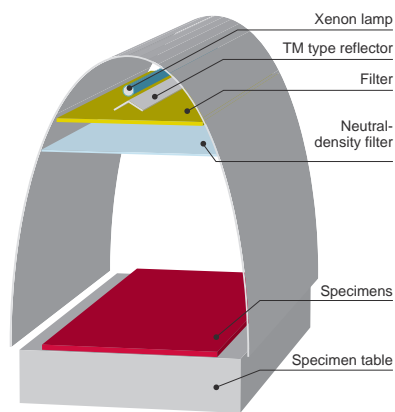

Basic structure

### Suitable for small products or little lot testing

medicine, chemical, food, paper, stationery, etc.



# XT750L

Closed circulation type

Temp. Range  
25<sub>to</sub>60±1°C



### Temp. control model with wide range



## UV Irradiance test by mercury lamp

### H40 Outside air intake type

<b>Lamp rated</b> <b>400 W</b> <small>(Electric discharge voltage current 130V 3.3A)</small>	<b>Specimens</b> <b>24 pcs.</b> <small>(Dimensions 150x70x1mm, 100x50x2mm)</small>
<b>Temp. Range</b> <b>57 ±3°C</b> <small>(BPT)</small>	<b>Specimens rotation</b> <b>1 rpm</b>



### H75 Outside air intake type

<b>Lamp rated</b> <b>750 W</b> <small>(Electric discharge voltage current 500V 1.6A)</small>	<b>Specimens</b> <b>3 pcs.</b> <small>(Dimensions 300x300x6.5mm)</small>
<b>Temp. Range</b> <b>45 ±5°C</b> <small>(CAT)</small>	<b>Specimens rotation</b> <b>3 rpm</b>



## Fade out test for paint or plywood

### Structure

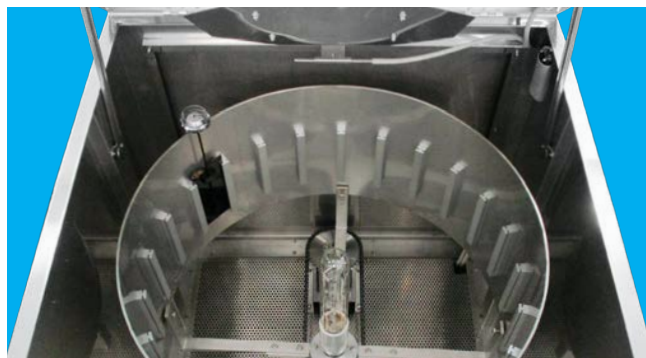
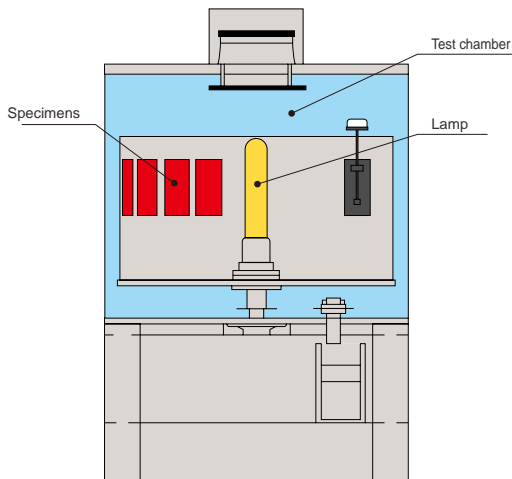

## UV deterioration test for safety glass

### Structure

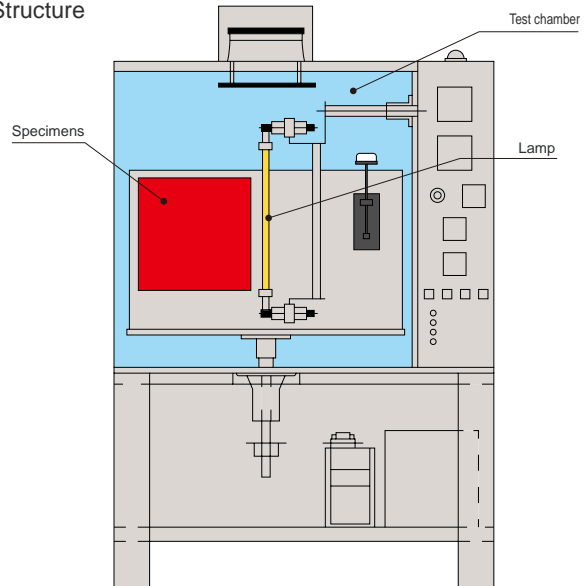

## Typical standards for UV irradiance test

Model	Standard No.	Name
H40	JIS K 5572	Phtharic resin enamel
	ISO 3917	Road vehicles -- Safety glazing materials -- Test methods for resistance to radiation, high temperature, humidity, fire and simulated weathering
H75	ISO 12543	Glass in building -- Laminated glass and laminated safety glass -- Part 1: Definitions and description of component parts
	JIS H 8685-1	Anodizing of aluminium and its alloys--Accerelated test of light fastness of coloured anodic oxidation coatings using artificial light
	JIS R 3212	Test methods of safety glazing materials for road vehicles
	JIS R 3205	Laminated glass

## Standard specimen holder

Specimens can be fixed with uniform irradiance/temp./air speed.

Applied model	Xenon weather meter		Metaling™ weather meter	Sunshine weather meter		UV fade meter	
	SX75 GX75	SX120 X75	MV3000	S300 S80	S80D S80	U48AU U48	U48AU U48
Shape							
Fixing method	Spring from back		Holding plate from back	Insert to guide from front		Holding plate from back	
Specimen dimensions	150x70x1mm			65x55x1mm			
Specimen irradiance area	136x56mm		136x48mm	136x70mm		51x41mm	

## Special specimen holders

Your requested holders can be made as special.

	Light and perspiration test container (JIS L0888)	Automobile interior material	Automobile glass	Ball
Shape				
	Thick materials	Plastic bottle	Finished product	Heavy articles
Shape				

## Pure water supplier for spray water Pure water is supplied for spray water



### PW1

Pure water is stored up to 230L, and supplied to specimen spray or vaporizer.

Deionizer is not included.

Spray

Vaporizer

Wet bulb pot

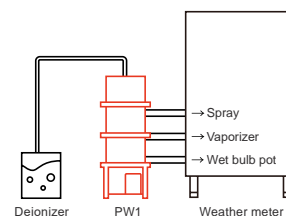

## Spray water temp. control device







### PWT

Spray water temperature is an important factor for the result of weathering test. Water temp is controllable: 20 to 40 ±3°C.

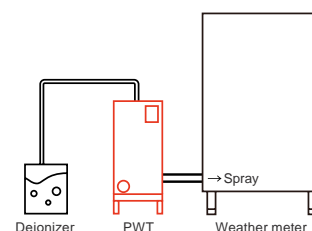
Deionizer is not included.

Spray



Products		Super Xenon Weather Meter			
Model		SX75	SX120	SX75-2D	
					
Light source	model Rated value Cooling Number of light sources	Xenon lamp WX7.5 7.5kW Water-cool 1	Xenon lamp WX12.0 12kW Water-cool 1	Xenon lamp WX7.5 7.5kW Water-cool 2(1x2chambers)	
Tests	Light	✓	✓	✓	
	Light + Surface spray(rain)	✓	✓	✓	
	Dark	✓	✓	✓	
	Dark + Surface spray(rain)	✓	✓	✓	
	Dark + Back spray(dew)	✓	✓	✓	
	Dark + Both sides spray	✓	✓	✓	
Irradiance	(Wave length: 300-400nm) (Filter: Daylight)	60to180W/m <sup>2</sup>	40to160W/m <sup>2</sup>	60to180W/m <sup>2</sup>	
Temp./Humid. range	Light	BPT	50to95±1°C	63to95±1°C	50to95±1°C
		Humidity	50to60±5%rh	40to60±5%rh	50to60±5%rh
	Light + Surface spray(rain)	CAT	28±1°C	No control	28±1°C
	Dark	CAT	38±1°C	38±1°C	38±1°C
		Humidity	95±5%rh	95±5%rh	95±5%rh
	Dark + Surface spray(rain)	CAT/Humidity	40±1°C/95%rh or greater	40±1°C/95%rh or greater	40±1°C/95%rh or greater
	Dark + Back spray(dew)	CAT	28±1°C	28°C±1°C	28±1°C
	Dark + Both sides spray	CAT	38±1°C	38°C±1°C	38±1°C
Number of specimens	Exclude BPT sensor / light receptor (Size)	51pcs. (150x70x1mm)	105pcs. (150x70x1mm)	51pcs.x2chambers=102pcs. (150x70x1mm)	
Specimen holder	Type/Number	Inclined/18pcs.	Inclined/36pcs.	Inclined/18pcs.x2chambers	
Specimen rotation rack	Diameter Rotating speed	φ580mm(option: φ648mm) 1or2rpm (selectable)	φ960mm(option: φ780mm) 1or2rpm(selectable)	φ580mm(option: φ648mm) 1or2rpm (selectable)	
Electric capacity	50Hz/60Hz Earth leakage breaker (ELB)	3phase200V Approx.61A ELB : 75A	3phase200V Approx.120A ELB : 150A	3phase200V Approx.61A(per chamber) ELB : 75A(per chamber)	
Required water	Wet bulb pot / Humidifier	Pure water	Approx.2.5L/h	Approx.4.5L/h	Approx.2.5L/h(per chamber)
	Surface spray	Pure water (at 0.1MPa)	Approx.0.48L/min	Approx.3.15L/min	Approx.0.48L/min(per chamber)
	Back spray	Pure water (at 0.1MPa)	Approx.0.24L/min	Approx.0.24L/min	Approx.0.24L/min(per chamber)
	Lamp cooling water	Tap / Cooling tower water (at water temp. 25°C)	Cooling tower water Approx.40L/min (at water temp. 34°C)	Approx.12L/min	Approx.6L/min(per chamber)
	Refrigerator	Cooling tower water (at water temp. 25°C)		Approx.42L/min	Approx.30L/min(per chamber)
Dimension	W x D x H (including pipes)	Approx.109x155x205cm	Approx.140x209x205cm	Approx.164x206x202cm	
	Operating weight	Approx.580kg	Approx.1,100kg	Approx.1,200kg	
Attached device	Radiometer	✓	✓	✓	
	Irradiance automatic controller	✓	✓	✓	
	BPT automatic controller	✓	✓	✓	
	Water cooled refrigerator for chamber	✓	✓	✓	
	Lamp cooling water circulator	✓	✓	✓	

CAT : Chamber Air Temperature, RT : Room Temperature



	Xenon Weather Meter					Metaling Weather Meter	
	GX75	X75	X75L	GX25	X25A	MV3000	M6T
							
	Xenon lamp WX7.5 7.5kW Water-cool 1	Xenon lamp WX7.5 7.5kW Water-cool 1	Xenon lamp WX7.5 7.5kW Water-cool 1	Xenon lamp WX2.5 2.5kW Water-cool 1	Xenon lamp AX2.5 2.5kW Air-cool 1	Metaling lamp M3.0 3kW Vertical type(Indirect water-cool) 1	Metaling lamp M6.0 6kW Horizontal type(Indirect water-cool) 1
	✓	✓	✓	✓	✓	✓	✓
	✓	✓	✓	option	✓	✓	✓
	✓	✓	✓	✓	✓	✓	✓
	✓	✓	✓	—	—	—	—
	✓	—	—	—	—	✓	✓ (dark+dew)
	✓	—	—	—	—	✓	—
	40to120W/m <sup>2</sup>	25to70W/m <sup>2</sup>	25to70W/m <sup>2</sup>	40to60W/m <sup>2</sup>	40to60W/m <sup>2</sup>	480 to 580W/m <sup>2</sup>	0.65 to 2.00kW/m <sup>2</sup>
	63to110±2°C	63to83±2°C (option:95°C)	12to80±1°C(CAT) (option:95°C)	63to110±2°C	63±2°C (option:95°C)	63to85±1°C	30to85±2°C
	50±5%rh	30to60±5%rh	30to70±5%rh	35to60±5%rh	35to60±5%rh	50±5%rh	30to70±5%rh
	38±2°C	No control	28±1°C	—	No control	28±1°C	No control
	38±2°C	38±2°C	5to80±1°C	38±2°C	38±2°C	30to50±1°C	5to100±2°C
	95±5%rh	95±5%rh	95±5%rh (CAT38°C)	95±5%rh	95±5%rh	95±5%rh (CAT38°C)	50to95±5%rh (CAT40°C) 90±5%rh (CAT70°C)
	40±2°C/95%rh or greater	40±2°C/95%rh or greater	40±1°C/95%rh or greater	—	—	—	—
	38±2°C	—	—	—	—	28±1°C	30to40±2°C
	38±2°C	—	—	—	—	38±1°C	—
	60pcs. (150x70x1mm)	105pcs. (150x70x1mm)	105pcs. (150x70x1mm)	96pcs. (65x55x1mm)	38pcs. (65x55x1mm)	13pcs. (150x70x1mm)	Effective exposure area 440x180mm (Excluding center area 50 x 115mm )
	Inclined/21pcs.	Inclined/36pcs.	Inclined/36pcs.	Inclined/18pcs.	Vertical/21pcs.	Vertical/15pcs.	—
	φ 648mm 2rpm	φ 960mm 1rpm	φ 960mm 1rpm	φ 508mm 3rpm	φ 508mm 3rpm	φ 400mm 3rpm	—
	3phase200V Approx.55A ELB : 75A	3phase200V Approx.58A ELB : 75A	3phase200V Approx.75A ELB : 100A	3phase200V Approx.43A ELB : 50A	3phase200V Approx.43A ELB : 50A	3phase200V Approx.46A ELB : 75A	3phase200V Approx.84A ELB : 125A
	Approx.5L/h	Wet bulb pot:about 0.5 L/h (tap water) Humidifier:about 7L/h	Approx.4.5L/h	Approx.5L/h	Approx.2.5L/h	Approx.2.5L/h	Approx.2.5L/h
	Approx.0.24L/min	Approx.3.15L/min	Approx.3.15L/min	—	Approx.0.16L/min	Approx.0.29L/min	Approx.4.35L/min
	Approx.0.24L/min	—	—	—	—	Approx.0.29L/min	—
	Approx.6L/min	Approx.6L/min	Cooling tower water Approx.40L/min (at water temp.34°C)	Approx.4L/min	—	Approx.6L/min	—
	—	—	—	—	—	Approx.18L/min	Approx.72L/min
	Approx.103x137x185cm	Approx.136x147x201cm	Approx.136x186x202cm	Approx.100x129x180cm	Approx.90x107x199cm	Approx.105x157x195cm	Approx.135x165x195cm
	Approx.540kg	Approx.550kg	Approx.940kg	Approx.400kg	Approx.390kg	Approx.620kg	Approx.860kg
	✓	✓	✓	✓	✓	✓	✓
	✓	✓	✓	✓	✓	✓	✓
	✓	✓	✓	✓	✓	✓	✓
	—	—	✓	—	—	✓	✓
	✓	✓	✓	✓	—	✓	✓

Product		Sunshine Weather Meter				
Model		S80	S80D	S80L	S80-2D	
						
Light source		Sunshine long-life carbon-arc lamp 1(4pairs)	Sunshine long-life carbon-arc lamp 1(4pairs)	Sunshine long-life carbon-arc lamp 1(4pairs)	Sunshine long-life carbon-arc lamp 2(4pairs x2)	
Continuous lighting time		78h	78h	78h	78h	
Irradiance	(Wavelength: 300 to 700nm)	255W/m <sup>2</sup> ±10%	255W/m <sup>2</sup> ±10%	255W/m <sup>2</sup> ±10%	255W/m <sup>2</sup> ±10%	
Tests	Light	✓	✓	✓	✓	
	Light + Surface spray(rain)	✓	✓	✓	✓	
	Dark	—	—	✓	—	
	Dark + Back spray(dew)	—	✓	—	—	
Temp./Humid. range	Light	BPT	63±3°C	63±3°C	Approx.17to80±1°C (CAT)	63±3°C
		Humidity	30to70±5%rh	30to70±5%rh	30to70±5%rh (BPT63°C)	30to70±5%rh
	Light + Surface spray(rain)	CAT	No control	No control	No control	No control
	Dark	CAT	—	—	5to80±1°C	—
		Humidity	—	—	20to95±5%rh	—
Dark + Back spray(dew)	CAT	—	30±2°C 95±5%rh	—	—	
Number of specimens	Exclude BPT sensor / light receptor (Size)	70pcs. (150x70x1mm)	76pcs. (150x70x1mm)	70pcs. (150x70x1mm)	70pcs.x2chambers=140pcs. (150x70x1mm)	
Specimen holder	Type/Number	Inclined/35pcs.	Vertical/38pcs.	Inclined/35pcs.	Inclined/35pcs.x2chambers	
Specimen rotation rack	Diameter Rotating speed	φ960mm 1rpm	φ960mm 1rpm	φ960mm 1rpm	φ960mm(per chamber) 1rpm	
Electric capacity	50Hz/60Hz Earth leakage breaker (ELB)	3phase200V Approx.39A ELB : 50A	3phase200V Approx.41A ELB : 50A	3phase200V Approx.60A ELB : 75A	3phase200V Approx.39A(per chamber) ELB : 50A(per chamber)	
Required water	Wet bulb pot	Tap water	Approx.0.5L/h	Approx.0.5L/h	Approx.0.5L/h	Approx.0.5L/h(per chamber)
	Humidifier	Pure water	Approx.7L/h	Approx.7L/h	Approx.7L/h	Approx.7L/h(per chamber)
	Surface spray	Pure water (at 0.1MPa)	Approx.25L/h (12min spray in 60min)	Approx.25L/h (12min spray in 60min)	Approx.25L/h (12min spray in 60min)	Approx.25L/h(per chamber) (12min spray in 60min)
	Lamp cooling water	Tap / Cooling tower water	—	Cooling wall : Approx.342L/h Back spray : Approx.10L/h	—	—
	Refrigerator	Cooling tower water	—	—	Approx.30L/min	—
Dimension	W x D x H (including pipes)	Approx.136x145x226cm	Approx.136x145x226cm	Approx.136x186x238cm	Approx.227x180x233cm	
	Operating weight	Approx.560kg	Approx.580kg	Approx.750kg	Approx.1,200kg	
Attached device	Radiometer	option	option	option	option	
	Irradiance automatic controller	—	—	—	—	
	BPT automatic controller	option	option	option	option	
	Others	—	Water cooler	—	—	



CAT : Chamber Air Temperature, RT : Room Temperature

	UV Fluorescent Weather Meter	UV Fade Meter		Xenon Weather Meter (Table top type)		Ultraviolet Fade Meter for Glass	
	FUV	U48	U48AU	XT750	XT750L	H40	H75
							
	UV fluorescent lamp FS-40 8	UV long-life carbon-arc lamp 1	UV long-life carbon-arc lamp 1	air-cool xenon lamp 1	air-cool xenon lamp 1	Mercury lamp (Rated 400W) 1	Mercury lamp (Rated 750W) 1
	—	48h	48h	—	—	—	—
	12to42W/m <sup>2</sup> (270-700nm) 0.47to1.48W/m <sup>2</sup> (310nm)	500±100W/m <sup>2</sup>	500±100W/m <sup>2</sup>	2,000to30,000lx*1	2,000to30,000lx*1	Electric discharge 130±10V, 3.3±0.4A	Electric discharge 500±50V, 1.6±0.2A
	✓	✓	✓	✓	✓	✓	✓
	option	—	—	—	—	—	—
	✓	—	—	—	—	—	—
	—	—	—	—	—	—	—
	50to80±3°C (28to30W/m <sup>2</sup> )	63±3°C	63±3°C	RT+10±2°C (CAT)	25to60±1°C (CAT)	57±3°C	45±5°C (CAT)
	No control	50%rh or less (No control)	35to50±5%rh	—	—	—	—
	option	—	—	—	—	—	—
	40to70±3°C	—	—	—	—	—	—
	No control	—	—	—	—	—	—
	—	—	—	—	—	—	—
	48pcs. (150x75x1mm)	108pcs. (65x55x1mm)	108pcs. (65x55x1mm)	Effective exposure area 250×250mm Table height 60mm	Effective exposure area 250×250mm Table height 60mm	24pcs. (150×70×1mm or 100×50×2mm)	3pcs. (300×300×6.5mm)
	26pcs.	Inclined/18pcs.	Inclined/18pcs.	—	—	—	—
	—	φ508mm 3rpm	φ508mm 3rpm	—	—	φ628mm 1rpm	φ574mm 3rpm
	1phase200V Approx.11A ELB : 15A	1phase200V Approx.21A ELB : 40A	1phase200V Approx.41A ELB : 50A	1phase200V Approx.12A ELB : 15A	1phase200V Approx.18A ELB : 20A	1phase100V Approx.10A ELB : 15A	1phase100V Approx.25A ELB : 30A
	Pure water Approx.2L/h	Approx.0.5L/h	Pure water Approx.7L/h	—	—	—	—
	option	—	—	—	—	—	—
	—	—	—	—	—	—	—
	—	—	—	—	—	—	—
	Approx.138×62×149cm	Approx.95×88×175cm	Approx.95×103×205cm	Approx.99×62×57cm	Approx.99×68×133cm	Approx.75×84×117cm	Approx.82×67×123cm
	Approx.210kg	Approx.280kg	Approx.300kg	Approx.90kg	Approx.200kg	Approx.90kg	Approx.130kg
	option	option	option	option	option	—	—
	✓	—	—	—	—	—	—
	—	option	option	—	—	—	—
	—	—	—	—	—	—	—

\*1 Equivalent to 10-138W/m<sup>2</sup> (300-700nm)

## Typical Standards and Applied Models

SUGA Test Instruments is participating in various industrial standardization of weather meters, and checking latest standards. We can supply proper test instruments those satisfy each test standards. Following table shows typical standards and applied models.

Industries	ISO/IEC	ASTM/SAE/AATCC/DIN	JIS/JASO/JEITA
	ISO 4892-1		JIS K 7350-1
	ISO 4892-2		JIS K 7350-2
	ISO 4892-3		JIS K 7350-3
	ISO 4892-4		JIS K 7350-4
	ISO 16474-1		
	ISO 16474-2	ASTM D6695	JIS K 5600-7-7
	ISO 16474-3	ASTM D4587	JIS K 5600-7-8
	ISO 16474-4	ASTM D822	JIS K 5981
		ASTM D3361	
		ASTM D5031	
		ASTM D7869	
Building	ISO 11431		JIS A 1415 / JIS A 1439
Printed Materials and Ink	ISO 12040		JIS K 5701-1
			JIS K 5701-1
Textiles	ISO 105-B02 ISO 105-B10	AATCC TM16	JIS L 0891
	ISO 105-B04	AATCC TM169	JIS L 0843
	ISO 105-B06		
		AATCC TM192	JIS L 0891
Aluminum	ISO 2135	AATCC TM16	JIS L 0842
Glass	ISO 3917		JIS A 5759
Rubber	ISO 4665		JIS K 6266
		ASTM D750	JIS K 6266
			JIS K 6404-4
Electric/Electronics	IEC 60068-2-5		
Solar battery	IEC 61215		
Automobile		SAE J2527	
		SAE J2412	
			JASO M 346
			JASO M 351
			JIS D 0205
			JIS D 5500
			JIS D 4604
			JIS D 0202
		SAE J2020 DIN 75202	
Railway		JIS E 4037	
Packing materials		JIS Z 0237 / JIS Z 1528	
Digital print	ISO 18930 / ISO 18937		JEITA CP-3901
Non-metal materials		ASTM G151	
		ASTM G155	
		ASTM G152	
		ASTM G153	
		ASTM G154	
Safety sign	ISO 17398		JIS Z 9107
			JIS Z 9117
Test Instruments			JIS B 7754
			JIS B 7753
			JIS B 7751

• Test standards are revised periodically, please check the latest standards.

• The compatible models marked with ✓ in the table above do not indicate that they are compatible with all the test methods described in the test standards. Please consult us separately.

✓:Applied, OP: Applied with option

	SX75 SX75-2D	SX120	GX75	X75	X75L	GX25	S80	S80D	S80L	FUV	U48AU	U48
	✓	✓	✓	✓	✓	✓	✓	✓	✓	✓		
	✓	✓	✓	OP	✓	✓				✓		
							✓	✓	✓			
	✓	✓	✓	✓	✓	✓	✓	✓	✓	✓		
	✓	✓	✓	OP	✓	✓				✓		
							✓	✓	✓			
							✓	✓	✓			
											✓	✓
	OP	OP	OP		OP							
	✓	✓	✓	✓	✓	✓	✓	✓	✓		✓	✓
	✓	✓	✓	✓	✓	OP						
							✓	✓	✓		✓	✓
	✓	✓	✓	✓	✓	✓						
	OP	OP	OP	OP	OP	OP						
	OP	OP	OP	OP	OP	OP						
							✓	✓	✓			
	✓	✓	✓	✓	✓	OP	✓	✓	✓		✓	✓
	✓	✓	✓	OP	✓	✓						
							✓	✓	✓			
	✓	✓	✓	✓	✓	✓				✓		
	✓	✓	✓	✓	✓	OP	✓	✓	✓	✓	✓	✓
	✓	✓	✓	OP	✓	✓						
	OP	OP			OP							
	✓	✓	✓	OP	✓							
	OP	OP	OP	OP	OP	OP						
	OP	OP	OP	OP	OP	OP						
	✓	✓	✓	✓	✓	✓						
	OP	OP	OP	OP	OP	OP	✓	✓	✓	✓	✓	✓
							✓	✓	✓			
							OP	OP	OP			
							✓	✓	✓		✓	✓
										✓		
	OP	OP	OP	OP	OP	OP						
	✓	✓	✓	✓	✓	✓	✓	✓	✓		✓	✓
	✓	✓	✓	✓	✓	✓	✓	✓	✓		✓	✓
	OP	OP			OP							
	✓	✓	✓	✓	✓	✓	✓	✓	✓	✓	✓	✓
	✓	OP	OP	OP	OP	OP						
							OP	OP	✓			
											OP	OP
										✓		
	✓	✓	✓	✓	✓	✓	✓	✓	✓			
	✓	✓	✓	✓	✓	✓	✓	✓	✓			
	✓	✓	✓	✓	✓	✓						
							✓	✓	✓			
											✓	✓

# ISO/IEC 17025 accredited calibration

ISO/IEC 17025 accredited calibration certification can be issued for radiometer, platinum resistance thermometer, and pressure gauge. This is certified by ANAB and able to issue the certification of the radiometer, platinum resistance thermometer sensor, and pressure gauge. ISO/IEC 17025 General requirements for the competence of testing and calibration laboratories.

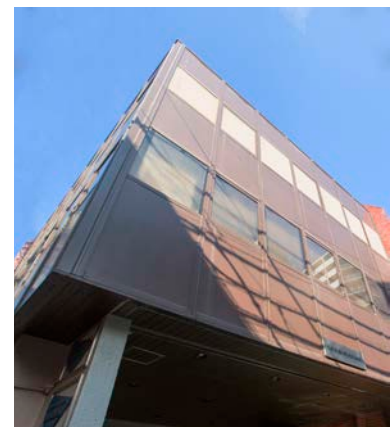

ANAB : The American National Standards Institute(ANSI)- American Society for Quality (ASQ) National Accreditation Board

ANAB certification

Light Research Institute (Calibration Dept.)

## Traceability with National measurement standards

Important calibration values for our test instruments is traced to National measurement standards.

ANAB is a signatory of the International Accreditation Forum (IAF) and International Laboratory Accreditation Cooperation (ILAC) multilateral recognition arrangements, and our calibration certificate is valid over 90 area in the world.

National Metrology Institute	Accredited laboratories	Primary standards	Secondary standards	
National Institute of Advanced Industrial Science and Technology	ANAB AC-2116 Suga Test Instrument Co., Ltd.	Spectral Irradiance Standard Bulb	Radiometer	Irradiance
	ANAB AC-2116 Suga Test Instrument Co., Ltd.	Digital Thermometer	Platinum Resistance Thermometer Digital Multi Thermometer	Temperature
			Black Panel Thermometer	Black Panel Temperature
			Black Standard Thermometer Black Standard Sensor	Black Standard Temperature
	ANAB AC-2116 Suga Test Instrument Co., Ltd.	Digital Pressure Gauge	Digital Pressure Gauge	Pressure
	JCSS 0039 Japan Electric Meters Inspection Corporation	Multi-product Calibrator	Power Hitester	AC wattage
			Multi-product Calibrator	DC voltage, current AC voltage
	A2LA 1400.03 Japan Quality Assurance Organization	Digital Ampere Meter	Digital Ampere Meter	AC current
	JCSS 0039 Japan Electric Meters Inspection Corporation	Multi-product Calibrator	Multi-product Calibrator	Resistance
	A2LA 1400.03 Japan Quality Assurance Organization	Digital Multimeter	Dial Resistor	
JCSS 0029 Japan Quality Assurance Organization	Weight		Weight	
JCSS 0618 Shinko Denshi Co., Ltd.	Digital Balance			
JCSS 0064 Japan Quality Assurance Organization	Caliper Checker	Digital Vernier Calipers	Length	
A2LA 1400.01 Japan Quality Assurance Organization	ThermoHygrometer	ThermoHygrometer	Temperature and Humidity	
A2LA 1400.01 Japan Quality Assurance Organization	Graduated cylinder		Volume	
A2LA 1400.01 Japan Quality Assurance Organization	Digital stopwatch		Time	
	Diffuse Reflectance Standards Standardization Plaque	Instrument White Standardization Plaque	XYZ Tristimulus Value	
Japan Industrial Standard Refractive index		Specular Glossiness Standard Plate	Specular Glossiness	
NRC		Haze Standard Plate	Haze Calibration Standard Plate Haze Value	

JCSS : Japan Calibration Service System, A2LA : American Association for Laboratory Accreditation

## Periodical calibration of measuring instruments to support accurate test

For accurate test, it is necessary to check measured values daily. Please ask calibration to SUGA periodically.



**Radiometer**

**R Series**

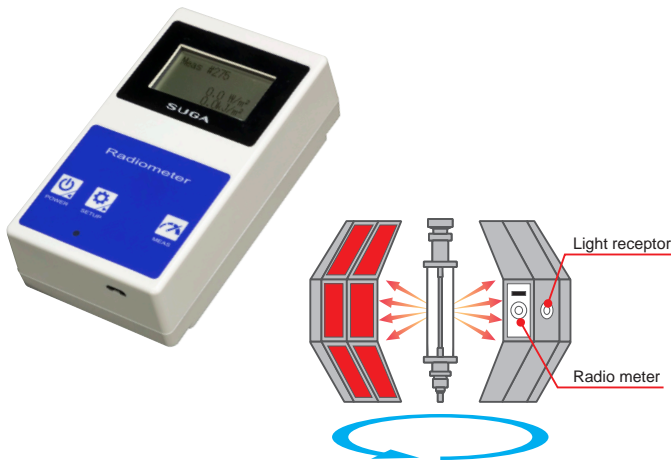

**Irradiance is measured at the same position as the specimen surface**

While rotating around the light source with the specimen, the "irradiance actually received on the test specimen surface" is measured.

**Measurements establish international standards and traceability**

Accurately calibrated using standard xenon lamps

**Automatic calibration of irradiance on the specimen surface for xenon and metaling™ lamp**

**Easy to read value by back light**

**Data transferred to PC**

**Various light source**

Combination of A, B, C

A: Light source	B: Measuring wavelength	C: Application
Water-cooled xenon lamp	300 to 400nm	Calibration
Air-cooled xenon lamp	300 to 700nm	Measuring
Metaling™ lamp	290 to 800nm	
Sunshine carbon arc	270 to 700nm	
UV fluorescent lamp	340nm	
UV carbon arc	420nm	

**Spectro-radiometer**

**SRA**

**Measureable multiple wavelength range**



**Black panel thermometer**

**BPT Series**



**Measuring maximum temperature of specimens accurately**



Temperature display

**Strict inspection criteria**

**White panel thermometer**

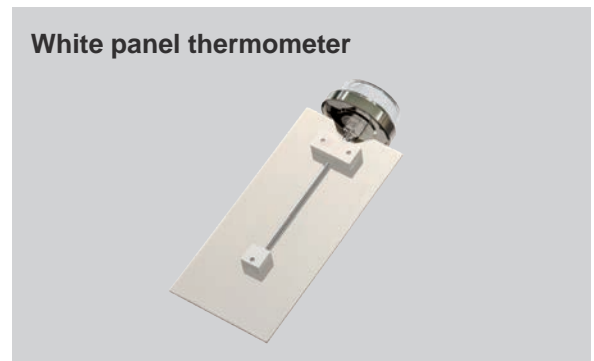

**Digital black panel thermometer**

**BPT-D2**

**Display instantaneous value and average value**





## Recognition of diversity of the natural environment

### Different climate conditions

Figure 1 Outdoor exposure results of Plastic plate (PC-1)

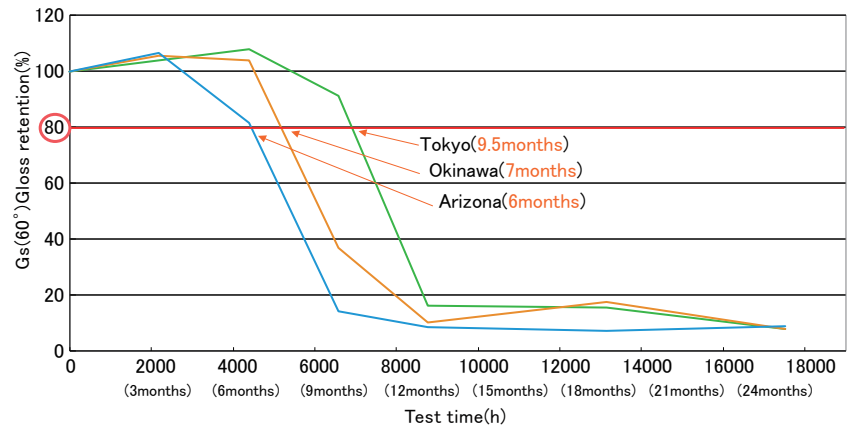

Figure 2 Annual climate comparison between Okinawa and Arizona

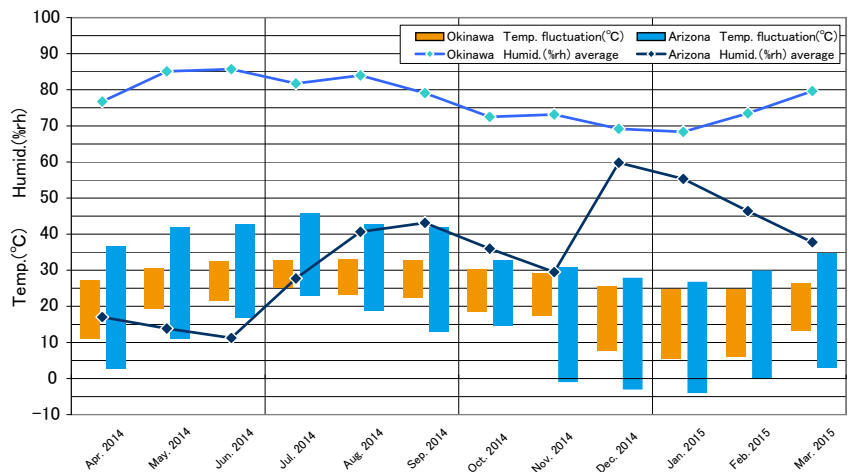

Figure 3 Different temp. with same irradiance

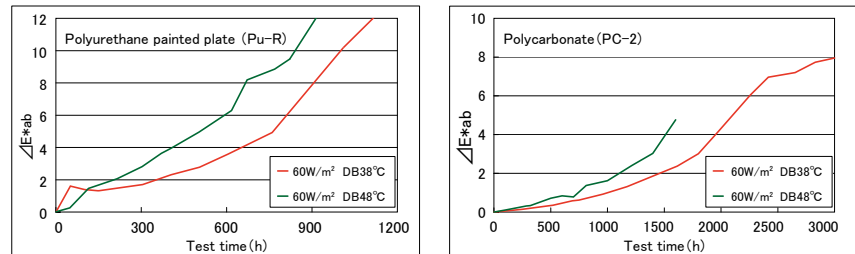
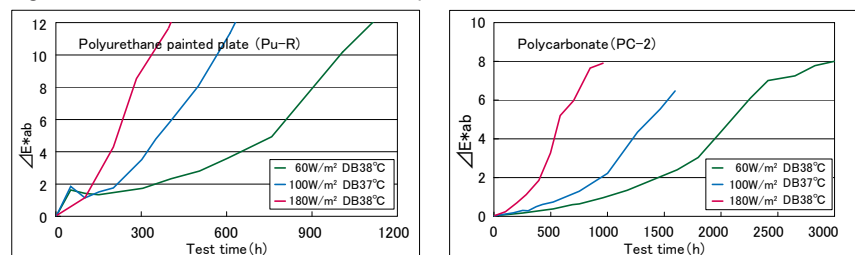
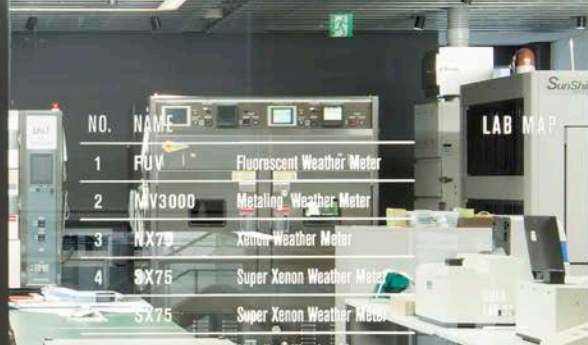

Figure 4 Different irradiance with same temp.







SUGA Laboratory

## Understand suitable testing conditions for the material

Test conditions

Weather meter	Super xenon weather meter		Metaling™ weather meter	Sunshine weather meter
	SX75	SX75	MV3000	S80
Irradiance(W/m <sup>2</sup> ) (300-400nm)	60	180	530	78.5
Filter	Daylight filter			UV expanded filter
BPT(°C)	63			
CAT(°C)	38			42
CAH(%rh)	50			
Spray (min)	18 min. out of 120min.			

Figure 5 Comparison by testing time

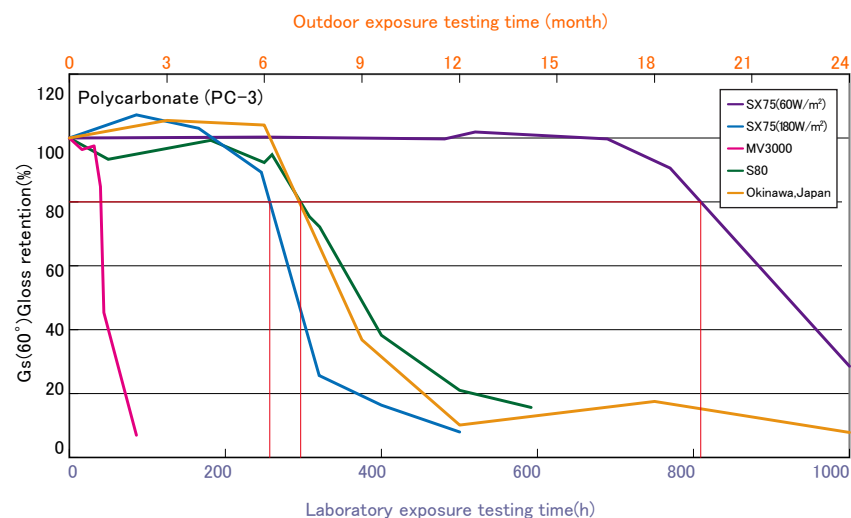
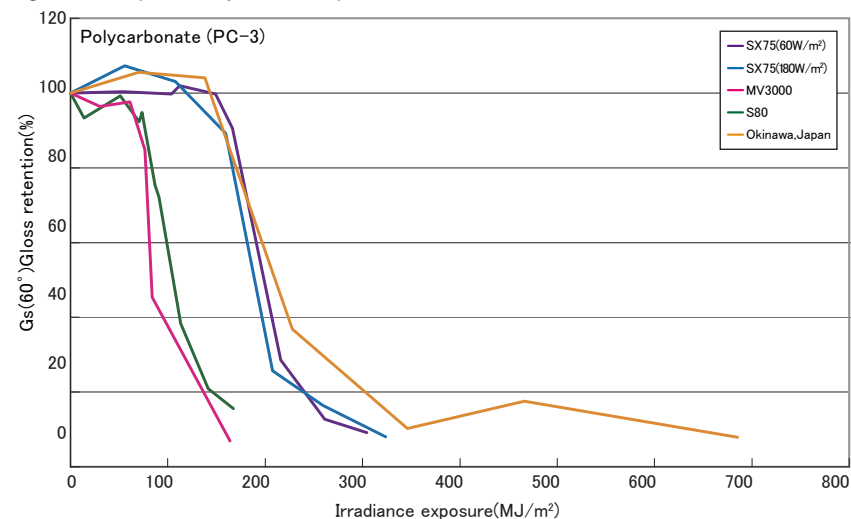

Figure 6 Comparison by radiant exposure



### Utilization of comparison standard specimens

- It is effective to use comparison specimen which is proved its correlation of outdoor exposure and weathering test.
- It is important to trace what is happened in the market by using comparison specimen.

# OER-1

Direct sunlight exposure with natural environment.

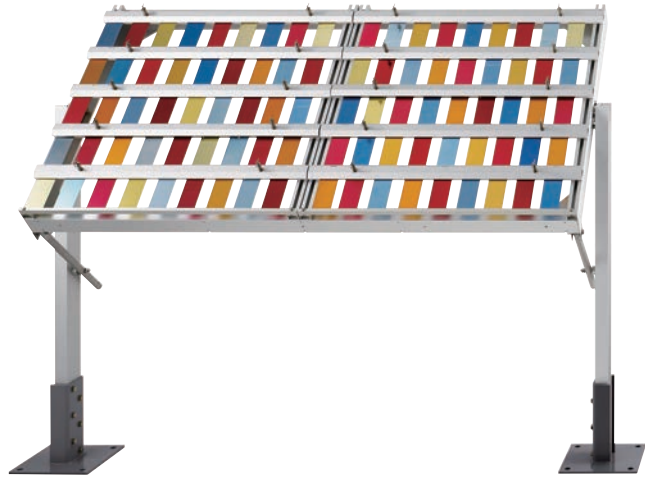

## OER-1G

Under glass exposures with natural air flow. 120 specimens.



## OER-G

Under glass exposures with closed air flow. 100 specimens.



## OER-1GZ (Custom design)

Under glass exposures with open-air type (specimens back).

## Typical standards for outdoor exposure testing

Industries	Standards
Paint	ISO 2810
	JIS K 5600-7-6
Metal & metal coating	ISO 8565
	JIS H 8502
	JIS H 0521
Automobile parts	JIS D 0205
Plastic	ISO 877-1, -2, -3
	JIS K 7219-1, -2
	JIS A 1456
Textiles, dyed products	ISO 105-B01, -B03
	JIS L 0841
General	JIS K 6860
	JIS Z 2381

## Data recording



### Illuminometer PH-3T

- Record integrated irradiance
- Measuring radiant exposure by each wavelength range
- Print out recorded data
- Data transfer to PC (option)

Measuring wavelength range		
UV	Visible	Infrared
300 to 400nm	400 to 700nm	700 to 3000nm



### Dew time meter DR-2T

- Measuring dew time, rain time, wet time
- Print out recorded data
- Data transfer to PC (option)

**Go Through  
with Advanced  
Weathering**



# SPX

Determining the fastness wavelength of a specimen via spectral radiation

<b>Wavelength</b> 220 to 520 nm 400 to 700 nm (selectable)	<b>Irradiance area</b> 160 x 17 mm	<b>Maximum resolution</b> 2 nm/mm (per 1mm slit width)	<b>Slit</b> 1 to 10 mm (continuously variable)
---	---------------------------------------	--	--



## Easy to check the fastness wavelength

Structure

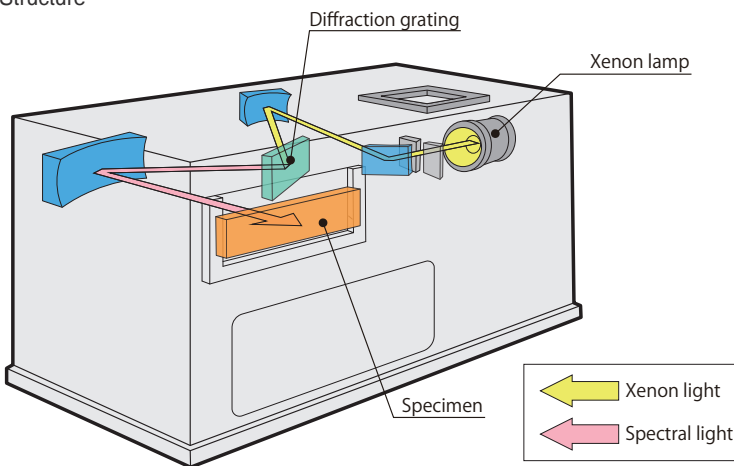

## Test examples

Polyascetal resin

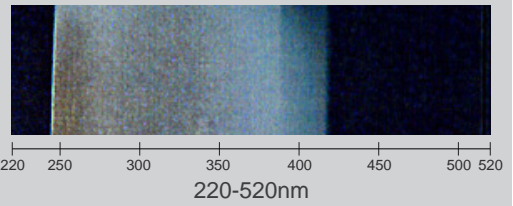

Tablet

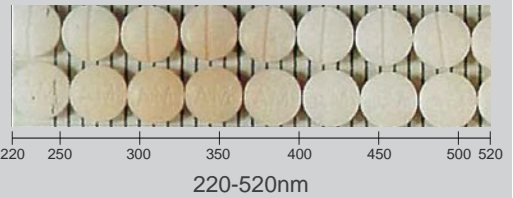

Medicine (liquid)

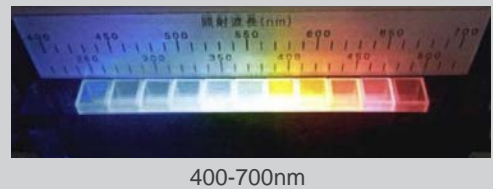

## Wavelength is selectable by one touch

220-520nm

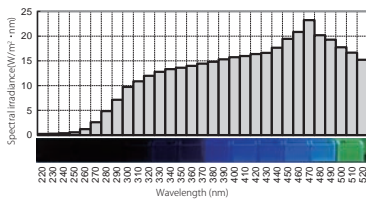

400-700nm

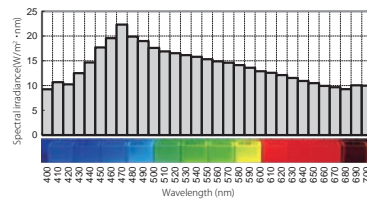

## Specification

Light source	300W air-cooled Xenon short arc lamp	Energy monitor (Monitors the lamp's life by observing light energy)	Irradiance range : at 220-520nm Monitoring 300nm energy Irradiance range : at 400-700nm Monitoring 480nm energy
Spectroscopy	Reflection grating	Automatic operation stop	When reaching radiant exposure When reaching irradiance setting time
Wavelength	220-520nm, 400-700nm (Selectable)	Dimensions	W77xD67xH65cm Operating weight 100kg
Irradiance area	W160 x H17mm (Height of monitor wavelength:15mm)		
Resolution	2nm/mm (per 1mm slit width)		
Slit	1 to 10mm continuously variable		

# SX-H<sub>2</sub>O<sub>2</sub>

**New test direction with Hydrogen Peroxide Solution Spray**  
 (Technical tie-up product with Toyota Central R&D Labs.,Inc.)

Maximum Irradiance <b>180</b> W/m <sup>2</sup> (300-400nm)	Specimens <b>51</b> pcs. (Dimensions 150x70x1mm)	Light <b>50 to 95</b> ±1 °C (BPT) <b>50 to 60</b> ±5%rh (at BPT 63 °C, 180 W/m <sup>2</sup> )	Dark <b>38</b> ±1 °C (CAT) <b>95</b> ±5%rh
--	--	---	---



**Achieved over 100 times acceleration compared with outdoor exposure against coating paint coating including titanium oxide**

**[Test Comparison]**

- SX-H<sub>2</sub>O<sub>2</sub> (180W/m<sup>2</sup>)
- S80 Sunshine carbon arc test (ISO 16474-4)
- X75 Xenon test (60W/m<sup>2</sup>) (ISO 16474-2)
- SX75 Super Xenon test (180W/m<sup>2</sup>) (ISO 16474-2)
- Outdoor exposure test (Okinawa, Miyakojima South 20°) (ISO 2810)

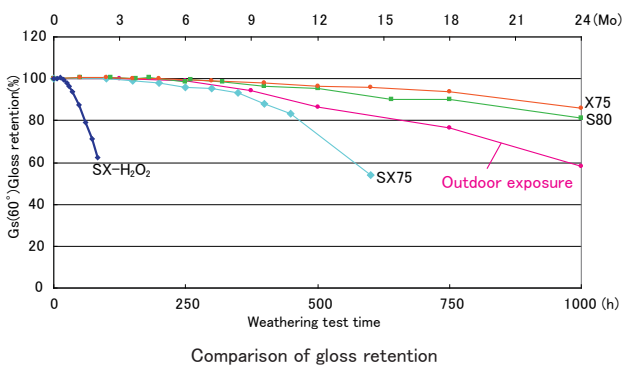
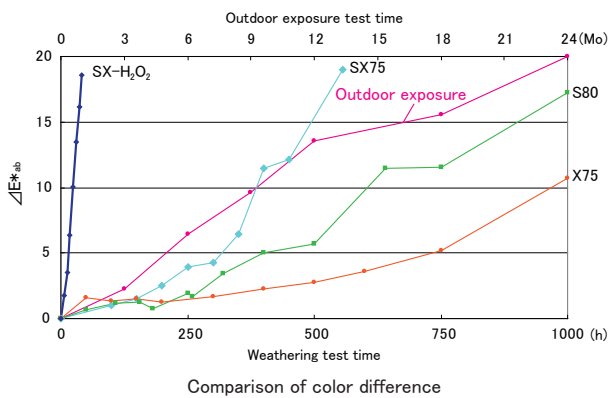

**Structure**

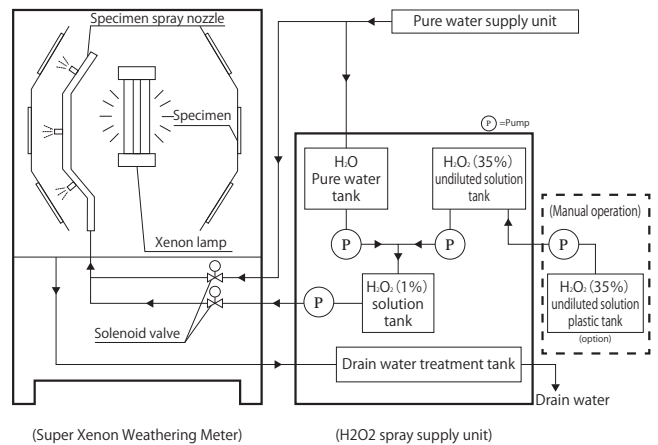

**Super Xenon Weathering Meter is highly adopted by automobile and paint manufacturers because of requiring high weathering products**

**Safety design from density control to drain treatment without touching hydrogen peroxide solution**

- Stable density automatically
- Drain water treatment

**Safety structure with closed circulation not to exhaust hydrogen peroxide**

- Closed circulation
- Cleaning for no-residual hydrogen peroxide solution
- Door lock



Suga's creative design and manufacturing to answer customer's needs

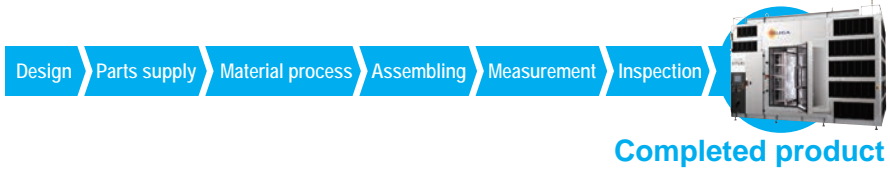

Design responded to the request



Integrated manufacturing including lamp

**Case1) Two test chambers with different light sources**



MV-SX-2D  
Metaling™ & Xenon



SX-S80-2D  
Xenon & Sunshine



MV-S80-2D  
Metaling™ & Sunshine

**Case 2) Light and Low temperature test**

Product deterioration under low temperature with light.



(Example: XL75Z with -40°C)

**Case 3) Light fastness test of digital print image**

Test under room light source with original filter. Ozone elimination device and SX75.



### Case 4) Large product test



Power meter



Asphalt



Photovoltaic module

### Case 5) Light and corrosion

Deterioration parameters (Salt spray, ozone, gas, etc.) are simulated as weathering and corrosion in one chamber.



CCT-1LX



Test chamber of CCT-1LXZ



CCT-RX

### Case 6) Light and dynamic test

Close to actual environment Tensile testing, vibration testing combined with electrical current.



There are many custom made instruments. For further information, please feel free to contact us.

Note that the specifications of the test instruments described in this catalog are subjected to change without notice due to improving. Please check the specification sheet for the current specifications and accessories / optional products. The test standards information on this catalog is those at the time this catalog was produced. Test standards are periodically reviewed and revised, please check the latest test standards.



**スガ試験機株式会社**  
**Suga Test Instruments Co.,Ltd.**

[www.suga-global.com](http://www.suga-global.com)  
[www.sugatest.co.jp](http://www.sugatest.co.jp)

Head Office / Laboratory  
Hidaka / Kawagoe Factory  
Branches

5-4-14 Shinjuku, Shinjuku-ku, Tokyo, 160-0022, Japan  
1973 -1 Takahagi, Hidaka-shi, Saitama, 350-1213, Japan  
Nagoya, Osaka, Hiroshima



Our calibration division is accredited to meet the requirements for MRA of ILAC by ANAB. This is conformity with ISO/IEC 17025.

**GNT100**

Suga is Awarded to **Global Niche Top Companies Selection 100** by Japanese government, Ministry of Economy, Trade and Industry.

TEL +81-3-3354-5241, FAX +81-3-3354-5275, Mail [i-sales@sugatest.co.jp](mailto:i-sales@sugatest.co.jp)